

RISA-Tekla Link

Version 15.0.0 - General Reference Manual



RISA Tech, Inc.

27442 Portola Parkway, Suite 200

Foothill Ranch, California 92610

(949) 951-5815

(949) 951-5848 (FAX)

risa.com

Copyright 2026 by RISA Tech, Inc. All rights reserved. No portion of the contents of this publication may be reproduced or transmitted in any means without the express written permission of RISA Tech, Inc. RISA and the RISA logo are registered trademarks of RISA Tech, Inc.

We have done our best to insure that the material found in this publication is both useful and accurate. However, please be aware that errors may exist in this publication, and that RISA Tech, Inc. makes no guarantees concerning accuracy of the information found here or in the use to which it may be put.

Table of Contents

Before You Begin	1	Read-Only Properties	118
Overview	1	Editable Properties	118
Program Capabilities	1	Ignored Properties	118
Environment Support	4	Mapping Priority	118
Supported Roles	6	Other Mapping Considerations	121
System Requirements	7	Technical Support	125
License Agreement	8		
Technical Support	8		
Installation	8		
Application Interface - RISACONNECTION	8		
Tekla Structures Interface	8		
RISA Tekla Link Browser	11		
Graphical Results View	13		
Folder Structure	14		
Registry and File Location Considerations	14		
Application Interface - RISACONNECTION	16		
RISACONNECTION-Tekla Link Integration Procedure	23		
RISACONNECTION Behavior from a Tekla Structures Model	29		
Component Specific Considerations	38		
Warning and Error Log - RISACONNECTION	54		
Application Interface - RISA-3D	75		
Tekla Structures Interface	76		
Folder Structure	78		
Application Interface - RISA-3D	79		
RISA-3D/Tekla Link Integration Procedure	82		
RISA-3D Behavior with a Tekla Structures Model	88		
Warning and Error Log - RISA-3D	111		
Mapping Behavior	114		
How Mapping Works	114		
RISACONNECTION Specific Mapping Considerations	117		

Before You Begin

Welcome to the RISA-Tekla Link General Reference manual. Please read this topic and pay particular attention to the [License Agreement](#). If you are a first time user of the RISA-Tekla Link it would be beneficial to browse through this manual to become familiar with the interface and capabilities.

Overview

The RISA-Tekla Link allows Tekla Structures users to be able to interact with RISA-3D and RISAConnection to get engineering calculations for members and connections. The capability between the two programs (RISA-3D and RISAConnection) is a separate path that is laid out below.

RISAConnection and Tekla Structures

The interface allows you to directly call up RISAConnection once you have your Tekla Structures model fully detailed and complete with connection loads. RISAConnection can then be used to adjust the connection as necessary to get a connection that passes all code prescribed checks. From there you can have the Tekla Structures model automatically update the connections .

Please see the [Tekla Structures to RISAConnection Procedure](#) topic for more details on how the RISA-Tekla Link works with RISAConnection.

RISA-3D and Tekla Structures

It is possible to either export a model from Tekla Structures to RISA-3D, or import a RISA-3D model into Tekla Structures. The Tekla Structures interface generates the analysis model and it is that analysis model which can then be exported to RISA-3D. For the import from RISA-3D you simply create a blank Tekla Structures model and import a RISA-3D model into Tekla Structures. Use the same Tekla Analysis Model and RISA-3D file for round-tripping between programs.

Please see the [Tekla Structures and RISA-3D Procedure](#) topic for more details on how the RISA-Tekla Link works with RISA-3D.

Multiple User Accounts on a Single Computer

When the RISA-Tekla Link is installed many of the components are added to the specific user account who installs the link. Thus, the link may not work if someone who is not using the link is the one who installs it.

If you run into this problem we have a utility to make this work called the **SetupToolbar.exe**. This utility is located in the **RISA\RISA Tekla Link\ Utility** folder. Just run this (noting that nothing appears to happen) and then start up Tekla Structures and you should now see the RISA Toolbar.

Program Capabilities

RISA-3D - Tekla Structures Link

The RISA-Tekla Link can currently support:

- Round-tripping of the model to track changes when going from Tekla to RISA to Tekla.
- Exporting a Tekla model to RISA-3D
- Importing a Tekla model from RISA-3D
- All hot-rolled steel shapes are supported.

- Geometry, materials, shape types, end releases, design parameters, end offsets, seismic detailing etc. are supported.
- Rigid links are supported.
- Project grids are supported.
- Point and line loads are supported.
- Load categories and combinations are supported.
- Reactions are currently supported from RISA-3D to Tekla Structures for single load combination or envelope solutions.

The RISA-Tekla Link does not support the following:

- Cold-formed materials are not supported.
- Wood materials are not supported.
- General materials are not supported.
- Concrete materials are not supported.
- Aluminum materials are not supported.

RISAConnection -Tekla Structures Link

The RISA Tekla Link can currently support the connections in the table below:

Connection Type	Tekla Structures Component	RISAConnection Description
Clip Angle Shear	Clip angle (141)	Girder(Column)/Beam Clip Angle Connection
End Plate Shear ¹	End plate (144)	Girder(Column)/Beam End Plate Connection
End Plate Moment ¹	"	Column/Beam Extended End Plate Moment Connection
End Plate Seismic Moment ²	"	Column/Beam Extended End Plate Moment Connection
End Plate Moment ¹	"	Column/Beam Flush End Plate Moment Connection
"	"	Column/Beam End Plate Moment Connection (Extended on the Tension Side)
Shear Tab	Shear plate simple (146)	Girder(Column)/Beam Shear Tab Connection
Shear Tab (full depth)	Full depth (184)	Girder/Beam Shear Tab Connection (full depth)
Shear Tab Through Plate	Shear plate tube column (189)	Column/Beam Shear Tab Connection where the column is a tube or pipe and the connection is a through plate
Flange Plate Moment	Bolted moment connection (134)	Column/Beam Flange Plate Moment
Flange Plate Seismic Moment ³	"	"
Directly Welded Moment	Column with stiffeners W (182)	Column/Beam Direct Weld Moment Connection
Seismic RBS Connections ⁴	Column with stiffeners W (182) & Dogbone (1)	Column/Beam Direct Weld Moment Seismic Connection
Shear and Moment Splices ⁵	Splice connection (77)	Beam Shear Tab Splice Connection
"	"	Column Shear Tab Splice Connection
"	"	Beam Moment Plate Splice Connection
"	"	Column Moment Plate Splice Connection

Connection Type	Tekla Structures Component	RISACONNECTION Description
"	"	Beam Direct Weld Moment Splice Connection
"	"	Column Direct Weld Moment Splice Connection
End Plate Splices ⁶	Joining plates (14)	Beam Extended End Plate Splice Connection
"	"	Column Extended End Plate Splice Connection
Vertical Braces ⁷	Wraparound gusset cross (60)	Vertical Brace Diagonal Connection (brace directly attached to gusset)
Vertical Braces ⁸	Hollow brace wraparound gusset (59)	Vertical Brace Diagonal Connection (brace and gusset attached with connection plate)
Vertical Braces ⁹	Wraparound gusset (58)	Vertical Brace Diagonal Connection specifically for WF's
Chevron Braces ⁷	Bolted gusset (11)	Chevron Brace Connection (brace directly attached to gusset)
Chevron Braces ⁸	Tube gusset (20)	Chevron Brace Connection (brace and gusset attached with connection plate)
Chevron Braces ⁹	Gusseted cross (62)	Chevron Brace Connection specifically for WF's
HSS Welded T	Stanchion weld (85)	HSS T Connection
Base Plate	US Base Plate (1047)	Single Column Base Plate

¹ The end plate connection will automatically determine which type of RISACONNECTION connection is present. If there is no weld from the end plate to the beam flanges the program will always use an End Plate Shear connection. If there is a weld of the beam flange to the end plate then the program will detect the presence of bolts above/- below each flange to determine whether the connection is flush, extended on both sides, or extended on one side.

² Seismic Connections for extended end plate moment connections are now supported, as long as they meet the BEEP bolt configuration from the AISC 358 specification (4 bolt or 8 bolt stiffened connections). In RISACONNECTION you can define these as: OMF (BEEP), IMF (BEEP) or SMF (BEEP).

³ Seismic Connections for flange plate moment connections are now supported, as long as they meet the BFP bolt configuration from the AISC 358 specification. In RISACONNECTION you can define these as: OMF (BFP), IMF (BFP) or SMF (BFP).

⁴ Seismic Connections for reduced beam sections are now supported. In RISACONNECTION you can define these as: OMF (RBS), IMF (RBS) or SMF (RBS). The WUF-W moment connection in RISACONNECTION is not supported in the RISA-Tekla Link.

⁵ For shear and moment splices built with Tekla Structures component 77, the RISA-Tekla Link will automatically recognize which RISACONNECTION connection is assigned. If flanges are welded then the program will use the direct weld moment splice. If there are flange plates then the program will use moment plate splices. If there is no flange weld or flange plates, then the shear tab splice will be used.

⁶ For end plate splices, RISACONNECTION currently only supports a specific layout of bolts. Therefore, for the RISA-Tekla link to design component 14 connections you must have: four rows of bolts, 2 columns of bolts, bolts above and below both flanges at equal spacings and the bolt position must be measured from the middle. View the connection in RISACONNECTION for a graphical representation.

⁷ Components 60 and 11 are supported for L's, LL's, C's and WT braces. They are also supported for tubes and pipes that are directly attached to the gusset. For more specifics see the [Component Specific Considerations](#) topic.

⁸ Components 59 and 20 are supported solely for tube and pipe braces that use a secondary knife plate that is then attached to the gusset. Note that there is no support with the RISA-Tekla Link for a WT intermediate element that connects the brace and gusset. This is supported in RISACONNECTION but there is no matching Component in Tekla Structures. For more specifics see the [Component Specific Considerations](#) topic.

⁹ Components 59 and 20 are supported solely for wide flange braces that use angles attached to the flanges and a shear plate attached to the web. For more specifics see the [Component Specific Considerations](#) topic.

RISACONNECTION Shape Type Considerations

RISACONNECTION can model the following *shear* connections:

- Wide flange or tube column to wide flange or channel beam and girder to beam shear connections using connectors made up of:
 - Single angles
 - Double angles
 - End plates
 - Shear tabs
- Wide flange column and beam shear tab splices.
- Rectangular tube to rectangular tube directly welded moment connections.

RISACONNECTION can model the following *moment* connections:

- Wide flange column to beam extended end plate connections
- Wide flange column to beam flange plate moment connections
- Wide flange column to beam direct weld connection
- Wide flange column and beam end plate splices
- Wide flange column and beam flange plate splices
- Wide flange column and beam direct weld splices
- Wide Flange, HSS Tube, Or HSS Pipe column base plates

RISACONNECTION can model the following *brace* connections:

- Single angle, double angle, WT, channel, wide flange, tube and pipe diagonal vertical brace connections with wide flange/tube/pipe columns and wide flange beams
- Single angle, double angle, WT, channel, wide flange, tube and pipe chevron vertical brace connections with wide flange, tube or pipe beams.

Environment Support

The RISA-Tekla Link currently supports the **US Imperial**, **US Metric** for BOTH RISA-3D and RISACONNECTION.

Additionally the **UK**, **German**, **Sweden**, **Norway**, **China**, **India**, and **Australasia** environments are supported only for RISACONNECTION. Below are some details regarding each environment.

US Imperial Environment Considerations

- This environment is mapped by default to the RISA AISC database (AISCdb32.fil). Any edits to this mapping can be made using the [Mapping File Editor](#).

US Metric Environment Considerations

- This environment is mapped by default to the RISA Canadian database (canada32.fil). Any edits to this mapping can be made using the [Mapping File Editor](#).
- Not all bolt diameters in Tekla Structures are supported by RISACONNECTION. For bolt diameters not supported, warning [W3501](#) will be given and the bolts will be updated to the nearest supported size in RISACONNECTION.

UK Environment Considerations

- This environment is mapped by default to the RISA British database (british32.fil) as well as the European database (euro32.fil). This Tekla Structures environment has shapes common to both databases so both were mapped. Any edits to this mapping can be made using the [Mapping File Editor](#).
- Bolt Standards and Materials in this environment are not supported in RISACconnection. Therefore, you will need to map the existing Tekla Structures bolts/materials to available bolts/materials in RISACconnection using the [Mapping File Editor](#).
- Not all bolt diameters in Tekla Structures are supported by RISACconnection. For bolt diameters not supported, warning [W3501](#) will be given and the bolts will be updated to the nearest supported size in RISACconnection.
- The British shape database in RISACconnection does not currently contain LL's in it. Therefore, if using these shapes you will not get proper mapping. You will need to manually map these shapes using the [Mapping File Editor](#).

German/Sweden/Norway Environment Considerations

- This environment is mapped by default to the RISA European database (euro32.fil). Any edits to this mapping can be made using the [Mapping File Editor](#).
- Bolt Standards and Materials in this environment are not supported in RISACconnection. Therefore, you will need to map the existing Tekla Structures bolts/materials to available bolts/materials in RISACconnection using the [Mapping File Editor](#).
- Not all bolt diameters in Tekla Structures are supported by RISACconnection. For bolt diameters not supported, warning [W3501](#) will be given and the bolts will be updated to the nearest supported size in RISACconnection.
- The European shape database in RISA does not currently contain any HSS, Pipes, WT's or LL's in it. Therefore, if using these shapes you will not get proper mapping. You will need to manually map these shapes using the [Mapping File Editor](#).
- For Component 182 there is an oddity in Tekla Structures where IPE profiles for the beam make the weld from the shear tab to the column disappear. This prevents the RISACconnection-Tekla Link from transferring the connection.

China Environment Considerations

- This environment is mapped by default to the RISA Chinese database (china32.fil). Any edits to this mapping can be made using the [Mapping File Editor](#).
- Bolt Standards and Materials in this environment are not supported in RISACconnection. Therefore, you will need to map the existing Tekla Structures bolts/materials to available bolts/materials in RISACconnection using the [Mapping File Editor](#).
- Not all bolt diameters in Tekla Structures are supported by RISACconnection. For bolt diameters not supported, warning [W3501](#) will be given and the bolts will be updated to the nearest supported size in RISACconnection.

India Environment Considerations

- This environment is mapped by default to the RISA Indian database (indian32.fil). Any edits to this mapping can be made using the [Mapping File Editor](#).
- Bolt Standards and Materials in this environment are not supported in RISACconnection. Therefore, you will need to map the existing Tekla Structures bolts/materials to available bolts/materials in RISACconnection using the [Mapping File Editor](#).
- Not all bolt diameters in Tekla Structures are supported by RISACconnection. For bolt diameters not supported, warning [W3501](#) will be given and the bolts will be updated to the nearest supported size in RISACconnection.

Australasia Environment Considerations

- This environment is mapped by default to the RISA Australian database (aussie32.fil). Any edits to this mapping can be made using the [Mapping File Editor](#).
- Bolt Standards and Materials in this environment are not supported in RISACONNECTION. Therefore, you will need to map the existing Tekla Structures bolts/materials to available bolts/materials in RISACONNECTION using the [Mapping File Editor](#).
- Not all bolt diameters in Tekla Structures are supported by RISACONNECTION. For bolt diameters not supported, warning [W3501](#) will be given and the bolts will be updated to the nearest supported size in RISACONNECTION.

Note:

- If the link is installed and used with a non-supported environment this message will be given:

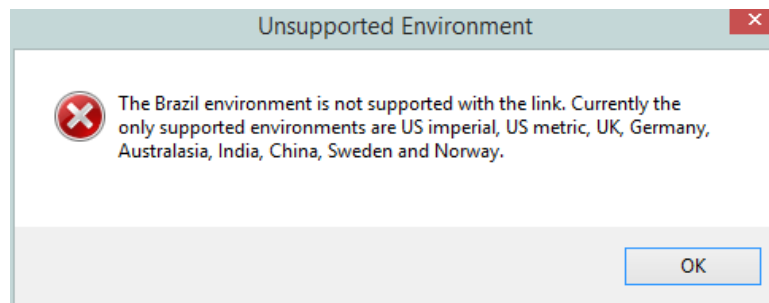

General Environment Consideration

To determine which environment is running the RISA-Tekla Link will look to the **TeklaStructuresModel.xml** file on either the **Environment** or the **XS_System** line.

Supported Roles

The RISA-Tekla Link currently supports **Imperial Engineering** and **Metric Engineering** for both RISA-3D and RISACONNECTION.

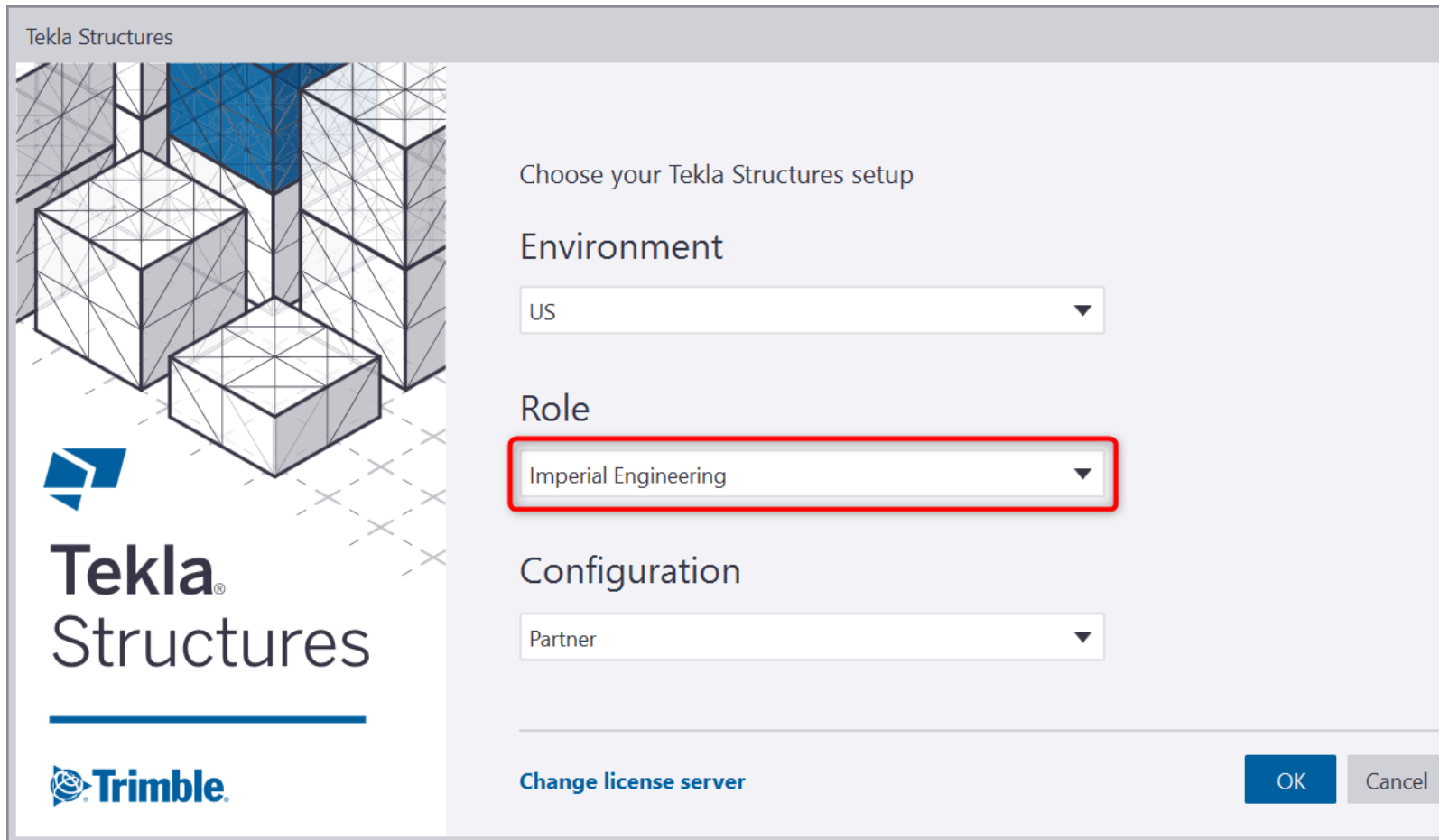

System Requirements

Operating System

One of the following operating systems is required:

- Microsoft Windows 11 (32 bit or 64 bit)

Software

The following programs and versions required:

- Tekla Structures 2021. The link works with any of the modeling configurations (Construction Modeling, Engineering or Steel Detailing), however it does NOT work with the Project Viewer.
- RISAConnection V16.0.0 or RISAConnection V16.0.0 Demo and higher to use the RISAConnection portion of the link.
- RISA-3D V23.0.0 files or later and the RISA-3D V23.0.0 version of the program must be installed if you wish to have the link actually launch RISA-3D. No version of RISA-3D is required to run the link. An exchange file will be generated that can then be passed to the engineer running RISA-3D.

Hardware

The following hardware is required:

- 1 GHz or faster processor
- 1024x768 or higher monitor resolution
- 2 (or more) button mouse, mouse wheel recommended
- 1 GB of RAM
- 4 GB of hard disk space

Demonstration Version

RISACONNECTION

The RISA-Tekla Link will let you go from Tekla Structures to RISACONNECTION Demo. The limitation is that the RISA-Tekla link will not let you transfer back to Tekla Structures to update the Tekla Structures model, or give any results information in Tekla Structures. This does, however, allow you to work with an engineer who owns RISACONNECTION. For more information on this behavior see the [RISA-Tekla Link Integration Procedure](#) topic.

RISA-3D

The RISA-Tekla Link will let you work with the RISA-3D Demo. However, the file size, saving and printing limitations from the demonstration version will limit the functionality of the link in demo mode.

License Agreement

For the full license agreement, please visit: risa.com/eula

Technical Support

Complete program support is available to registered owners of RISACONNECTION. This support is provided for the life of the program. The "life of the program" is defined as the time period for which that version of the program is the current version. In other words, whenever a new version of RISACONNECTION is released, the life of the previous version is considered to be ended. Technical support is a limited resource; first priority will always be given to those clients who are current on their maintenance.

See [Technical Support](#) for a list of your support options.

Installation

Please visit our website at: <https://secure.risa.com/index/downloads> to download the latest version.

Application Interface - RISACONNECTION

Here we will give you a quick outline of the interface. See the [RISA-Tekla Link Connection Procedure](#) and [RISACONNECTION Behavior](#) topics for more information.

Tekla Structures Interface

After the link is installed, RISACONNECTION buttons will appear in the Tekla Structures interface as follows.

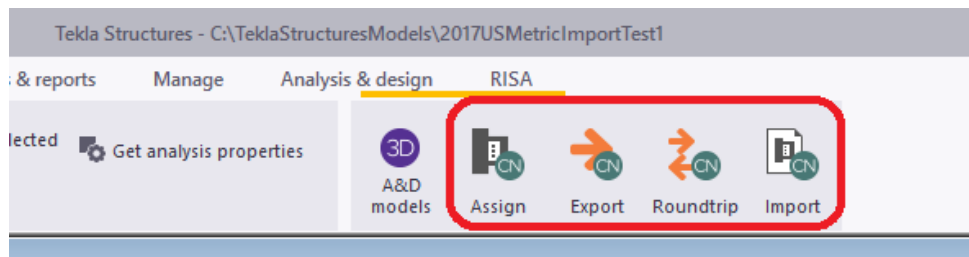

Tekla Structures 2021



The **RISA - Assign Connections** selection is used to determine which connections you wish to transfer to RISACONNECTION. By default all connections are exported.

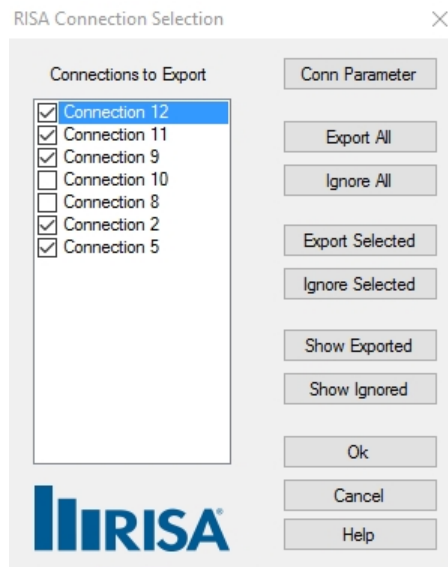

The main function of this dialog is to determine which connections you want to send to RISACONNECTION for design. You may wish for some connections not to export to RISACONNECTION if they've already been designed, or if you know that RISACONNECTION does not yet have the capability to design that type of connection. The connections with checkboxes checked define the connections that will be designed with RISACONNECTION and the program defaults to include all connections. From there you can click to uncheck a given connection, or use the buttons to the right. The functions are as follows:

- Clicking the **Conn Parameter** button to get information about the connection (name, ID, welding/bolting designations, etc). From this dialog the "Connection Name" can be updated. This value is what is used as the designation in RISACONNECTION. By default the CONNECTION_RUNNING_NUMBER is populated, but this can be modified to something more meaningful to the engineer if required.

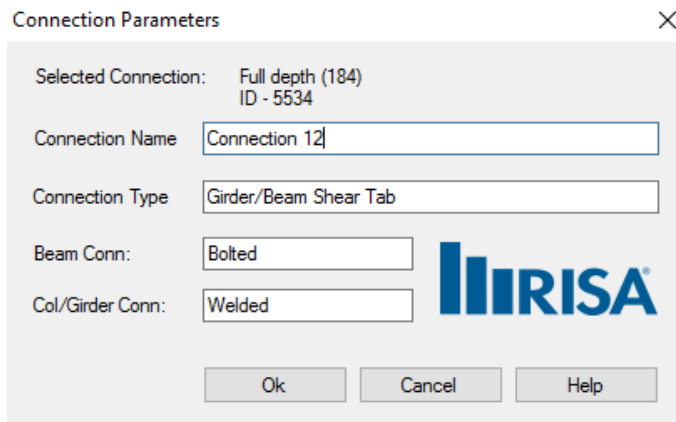

- **Export All/Ignore All** buttons will either check all connections or uncheck all connections. If you only wish to transfer a select few connections then you may start with **Ignore All** then select the individual connections you wish to transfer.
- The **Export/Ignore Selected** buttons allow you to make a graphical selection of the model in Tekla Structures prior to entering this dialog. When you enter this dialog with a graphical selection these buttons will check/uncheck the appropriate connections based on that selection.
- The **Show/Ignore Exported** buttons will select the exported/ignored connections in the Tekla Structures model view.



The **RISA - Design Connections** selection is used to send the Tekla Structures model to RISACONNECTION for connection design. From RISACONNECTION the connections can have their pieces and parts updated to create a con-

nection that passes all code checks/limit states. Pressing the **Export to Tekla** button from RISACONNECTION will update the Tekla Structures model with any changes from RISACONNECTION. See the [RISA-Tekla Link Integration Procedure](#) for step-by-step information.



The **RISA - Roundtrip Design Connections** selection will do a full round trip between Tekla Structures and RISACONNECTION. This means that the model will be sent to RISACONNECTION, any applicable connections will be checked/solved in RISACONNECTION, and the model will then be exported back to Tekla Structures. Be very careful using this tool, as many changes can potentially happen to the Tekla Structures model that may not have been directly specified by the user. RISACONNECTION has limitations and these are imposed on the Tekla Structures connections as well, which can cause automatic updates to the connection.



The **RISA - Show Results** selection will open up the RISA-Tekla Link dialog showing the design results and any errors/warnings.

Note:

- Note that this button will only show results if the model has been previously sent to RISACONNECTION.
- If you do not see the link pop up, click the  button on the taskbar.

RISA Tekla Link Browser

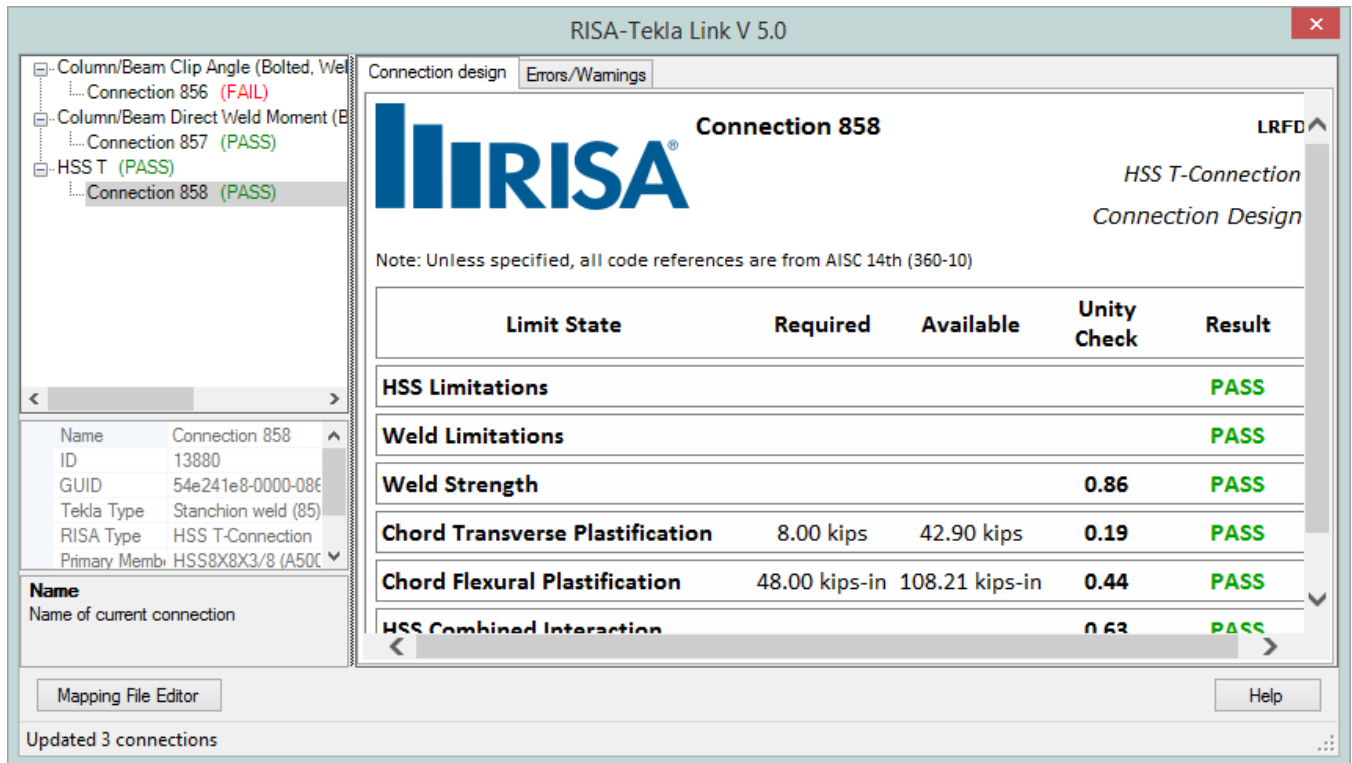

This RISA-Tekla link results browser gives an overall summary of the project, as well as allows you to view each individual connection. For each individual connection there are two tabs: **Connection design** and **Errors/Warnings**.

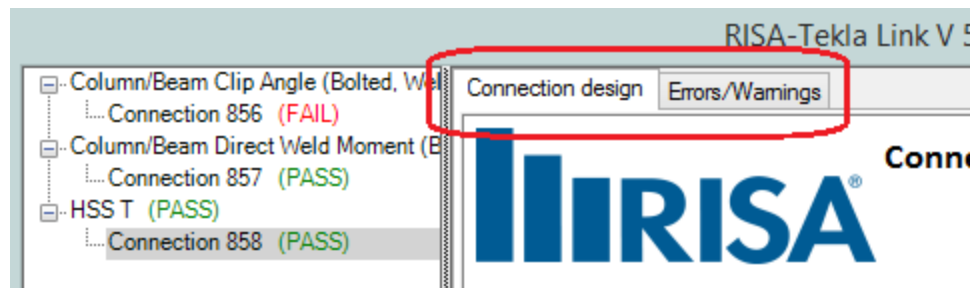

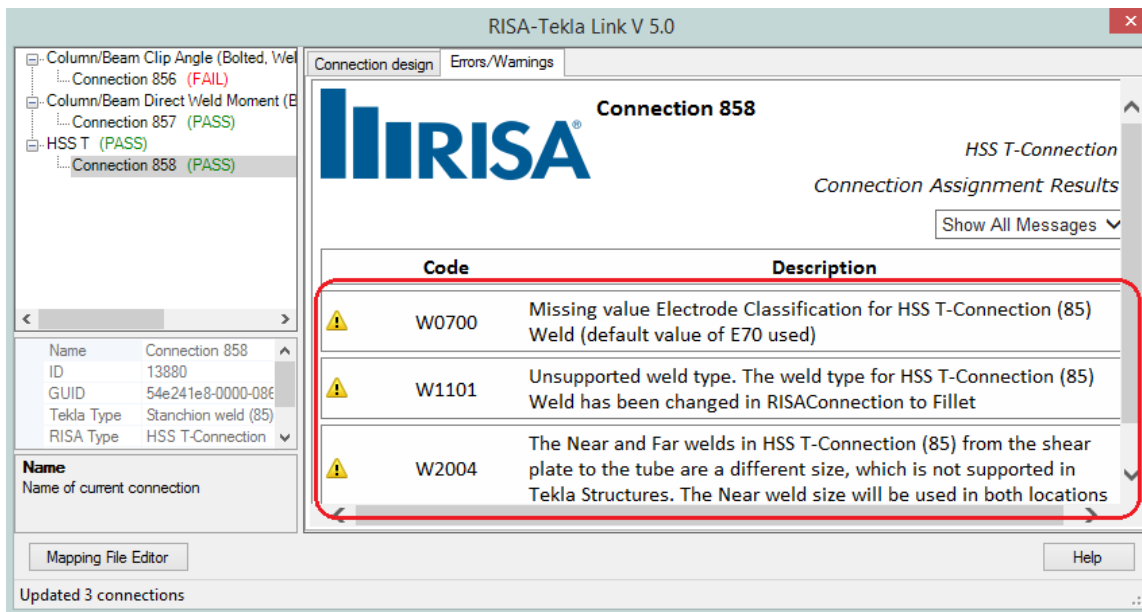

The **Connection design** tab will show each limit state and the corresponding Pass/Fail.

The **Errors/Warnings** tab will show warnings for any connection components that were not transferred, or give an error if the connection was not able to be transferred at all.

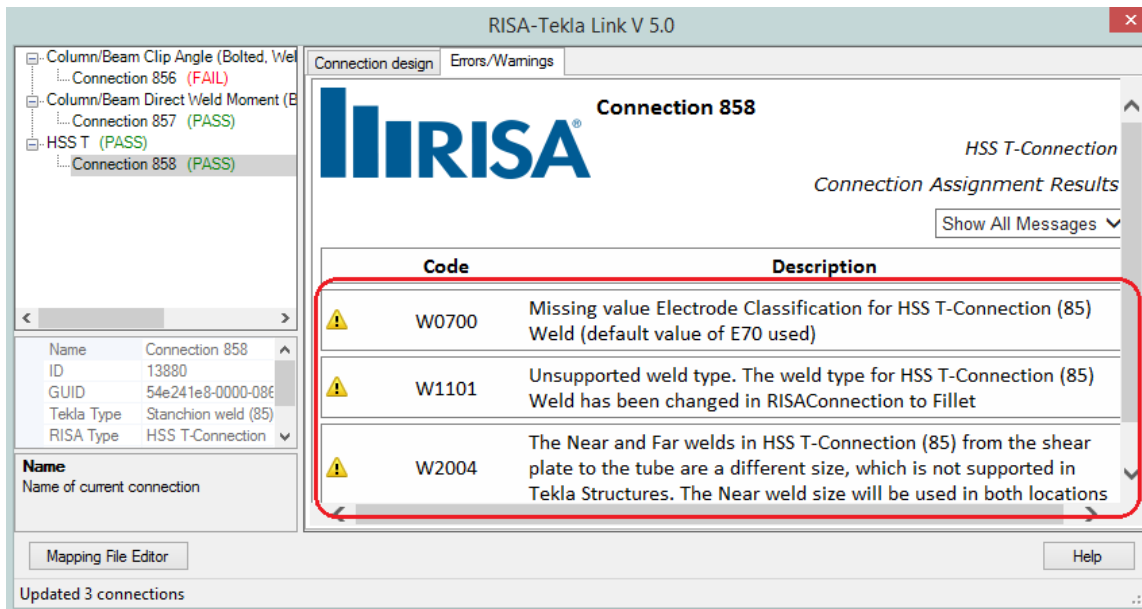

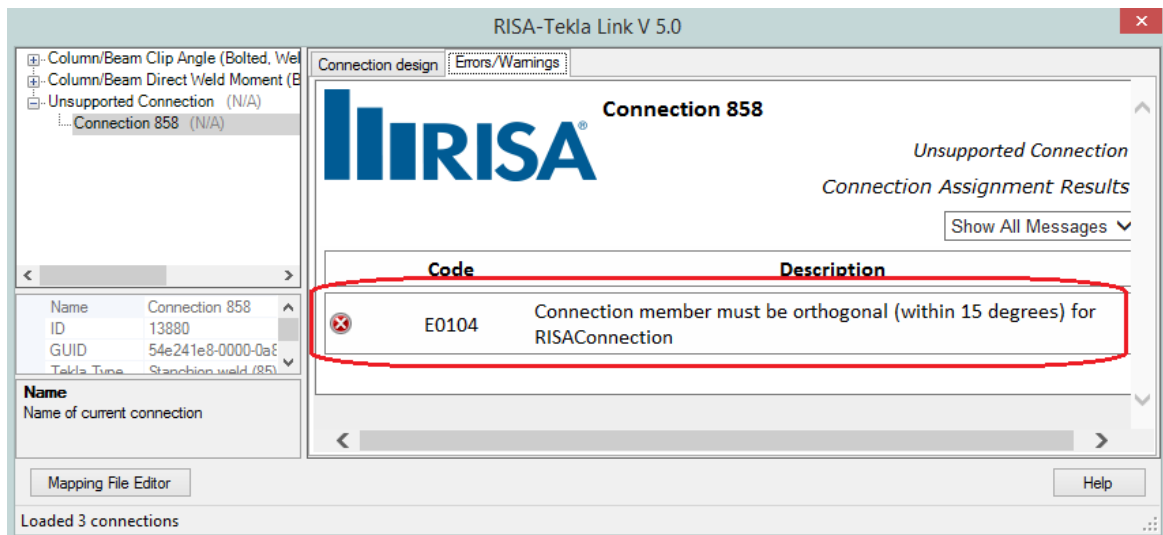
**Note:**

- There are many things that do not translate between RISAConnection and Tekla Structures. This in turn can cause either the connection to not go to RISAConnection, or some properties of the connection may not go to RISAConnection. For a list of these see the [Warning-Error Log](#) topic.

Graphical Results View

After the results are brought back into Tekla Structures the graphic view shows the connections by their color-coded results, green indicating a passing connection and red a failing connection.

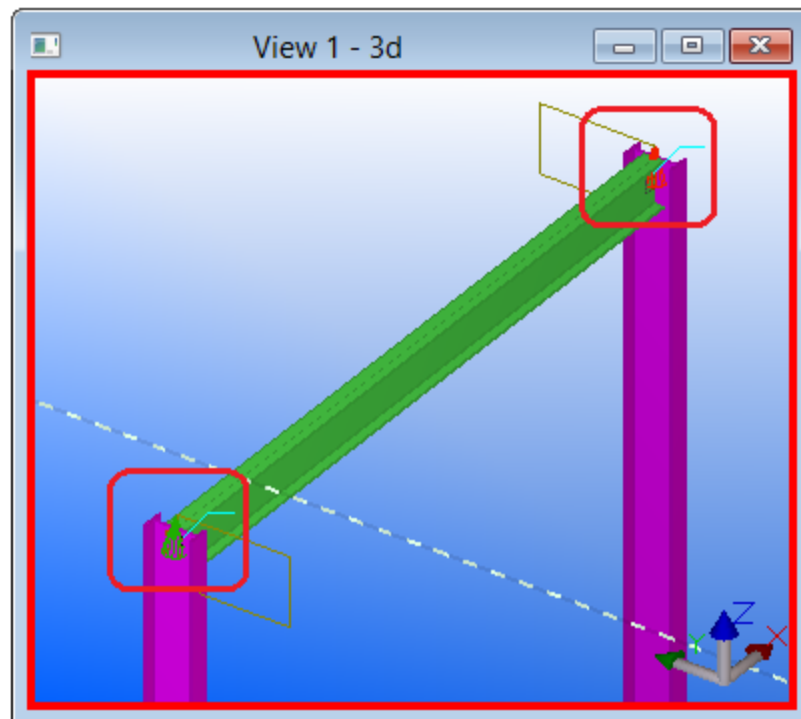
**Note:**

- This graphical results view is not available for all environments for all supported connections. This feature is also used in Tekla Structures, so there is conflicting functionality in certain cases.

Folder Structure

When the model is transferred to RISACONNECTION there are two files created in the directory of the Tekla file.

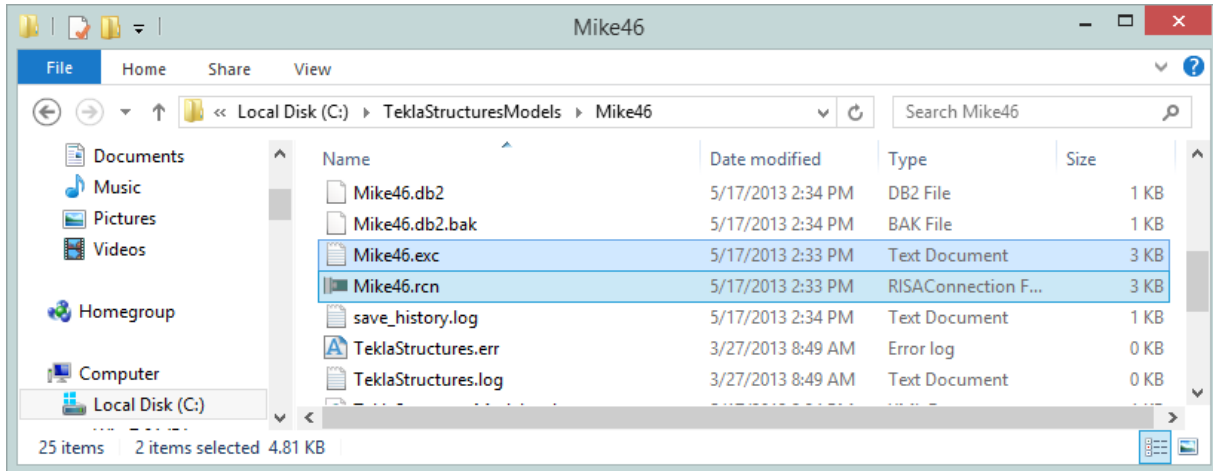

There is a ".exc" file and a ".rcn" file. The ".exc" file works as the exchange file between Tekla Structures and RISACONNECTION. The ".rcn" file is the RISACONNECTION input file. This prevents any information confusion in the link.

Registry and File Location Considerations

The RISA-Tekla Link relies on many different files to work properly. Information from Tekla Structures, RISACONNECTION and the RISA-Tekla Link itself is found by looking to either the registry directly, or to an INI file. Here is where we look for different items.

Note:

- The default location for each of these files will be in the default C:\RISA or C:\RISA\RISA Tekla Link folders. Only a catastrophic installation problem or manual editing of files and registry locations should break this functionality.

RISACONNECTION.exe

With the link we directly open RISACONNECTION. To do this we look for this RISACONNECTION.exe file from this location in the registry:

HKEY_LOCAL_MACHINE - SOFTWARE - Microsoft - Windows - App Paths - RISACONNECTION.exe

If the RISACONNECTION.exe is not located in this path then the link will not work properly.

TeklaLink.exe

Both running the RISA-Tekla Link in Tekla Structures AND sending information from RISACONNECTION back requires finding the TeklaLink.exe. We look in this location in the registry:

HKEY_LOCAL_MACHINE - SOFTWARE - Microsoft - Windows - App Paths - TeklaLink.exe

RISACONNECTION.ini

The RISACONNECTION.ini file gives the location where RISA's shape databases are located. The RISA-Tekla Link uses these shape databases to map Tekla Structures shape names to RISA shape names. Thus, the link needs to know where this file is located. It will look for the RISACONNECTION.ini from this location in the registry:

HKEY_CURRENT_USER - Software - RISA Technologies - RISACONNECTION - Version # - INI Path

TeklaLinkInfo.ini

The TeklaLinkInfo.ini gives the location where the RISA-Tekla Link mapping files are located. These mapping files are used to map the Tekla Structures shape names to the RISA shape names. It will look for the RISAConnection.ini from this location in the registry:

HKEY_CURRENT_USER - Software - RISA Technologies - RISATeklaLink - *Version #* - INI Path

Application Interface - RISACONNECTION

Here we will give you a quick outline of the interface. See the [RISA-Tekla Link Connection Procedure](#) and [RISACONNECTION Behavior](#) topics for more information.

Tekla Structures Interface

After the link is installed, RISACONNECTION buttons will appear in the Tekla Structures interface as follows.

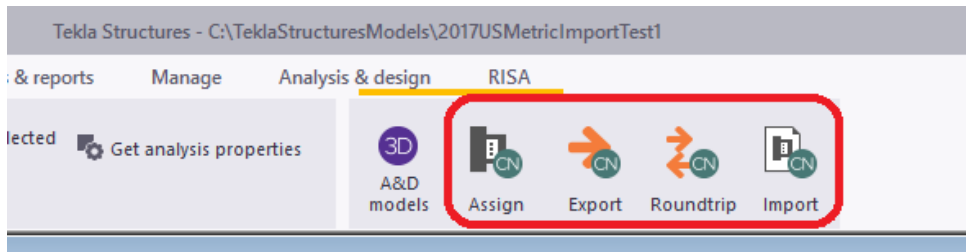

Tekla Structures 2021



The **RISA - Assign Connections** selection is used to determine which connections you wish to transfer to RISACONNECTION. By default all connections are exported.

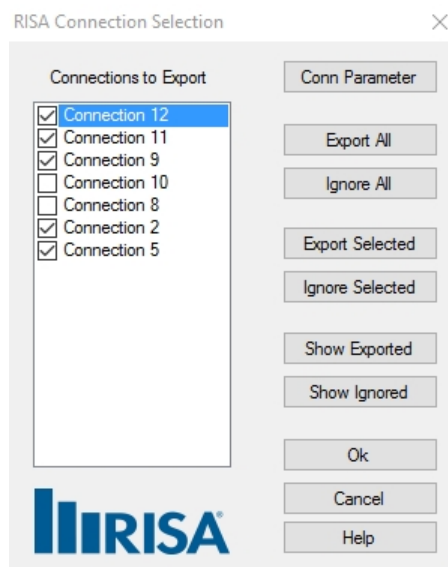

The main function of this dialog is to determine which connections you want to send to RISACONNECTION for design. You may wish for some connections not to export to RISACONNECTION if they've already been designed, or if you know that RISACONNECTION does not yet have the capability to design that type of connection. The connections with checkboxes checked define the connections that will be designed with RISACONNECTION and the program defaults to include all connections. From there you can click to uncheck a given connection, or use the buttons to the right. The functions are as follows:

- Clicking the **Conn Parameter** button to get information about the connection (name, ID, welding/bolting designations, etc). From this dialog the "Connection Name" can be updated. This value is what is used as the designation in RISACONNECTION. By default the CONNECTION_RUNNING_NUMBER is populated, but this can be modified to something more meaningful to the engineer if required.

Connection Parameters

Selected Connection: Full depth (184)
ID - 5534

Connection Name:

Connection Type:

Beam Conn.:

Col/Girder Conn.:

Ok Cancel Help

- **Export All/Ignore All** buttons will either check all connections or uncheck all connections. If you only wish to transfer a select few connections then you may start with **Ignore All** then select the individual connections you wish to transfer.
- The **Export/Ignore Selected** buttons allow you to make a graphical selection of the model in Tekla Structures prior to entering this dialog. When you enter this dialog with a graphical selection these buttons will check/uncheck the appropriate connections based on that selection.
- The **Show/Ignore Exported** buttons will select the exported/ignored connections in the Tekla Structures model view.



The **RISA - Design Connections**  selection is used to send the Tekla Structures model to RISACONNECTION for connection design. From RISACONNECTION the connections can have their pieces and parts updated to create a con-

nection that passes all code checks/limit states. Pressing the **Export to Tekla**  button from RISACONNECTION will update the Tekla Structures model with any changes from RISACONNECTION. See the [RISA-Tekla Link Integration Procedure](#) for step-by-step information.



The **RISA - Roundtrip Design Connections**  selection will do a full round trip between Tekla Structures and RISACONNECTION. This means that the model will be sent to RISACONNECTION, any applicable connections will be checked/solved in RISACONNECTION, and the model will then be exported back to Tekla Structures. Be very careful using this tool, as many changes can potentially happen to the Tekla Structures model that may not have been directly specified by the user. RISACONNECTION has limitations and these are imposed on the Tekla Structures connections as well, which can cause automatic updates to the connection.



The **RISA - Show Results**  selection will open up the RISA-Tekla Link dialog showing the design results and any errors/warnings.

Note:

- Note that this button will only show results if the model has been previously sent to RISACONNECTION.
- If you do not see the link pop up, click the  button on the taskbar.

RISA Tekla Link Browser

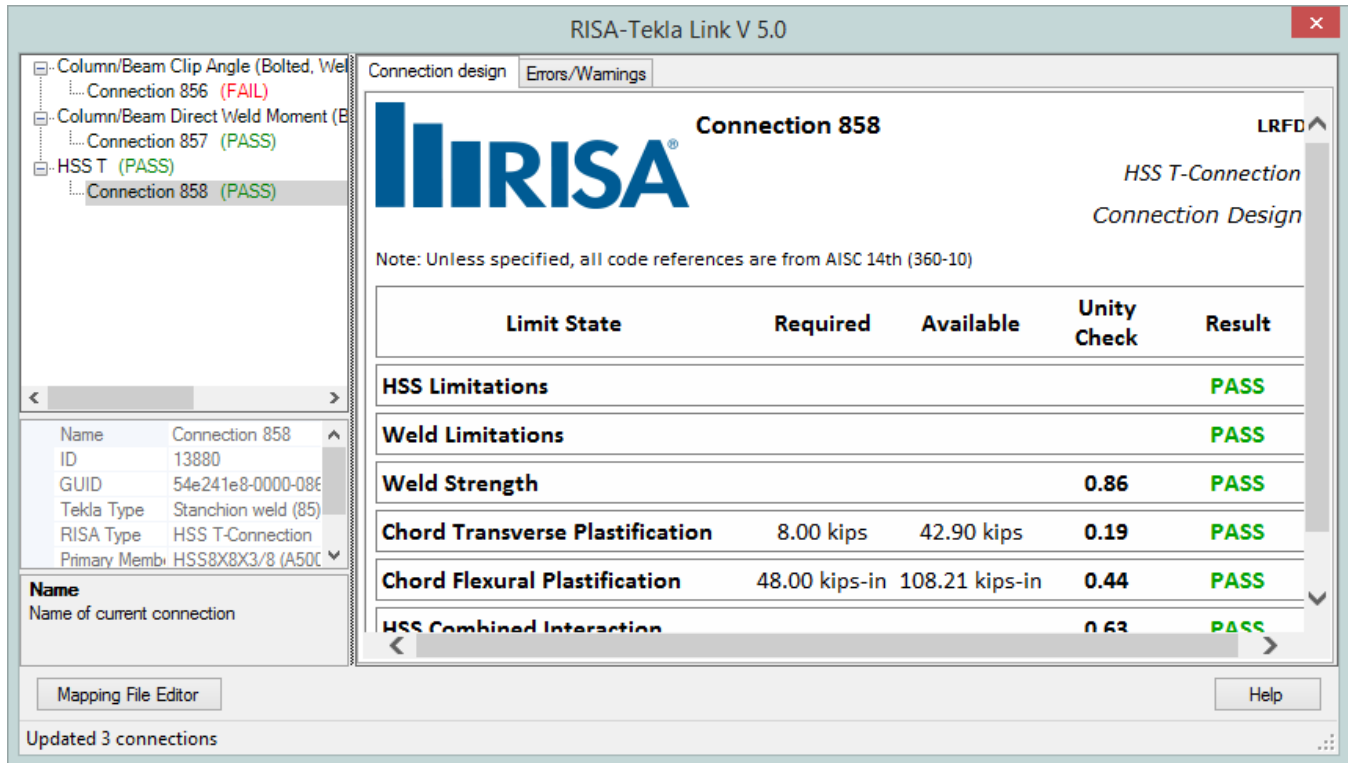

This RISA-Tekla link results browser gives an overall summary of the project, as well as allows you to view each individual connection. For each individual connection there are two tabs: **Connection design** and **Errors/Warnings**.

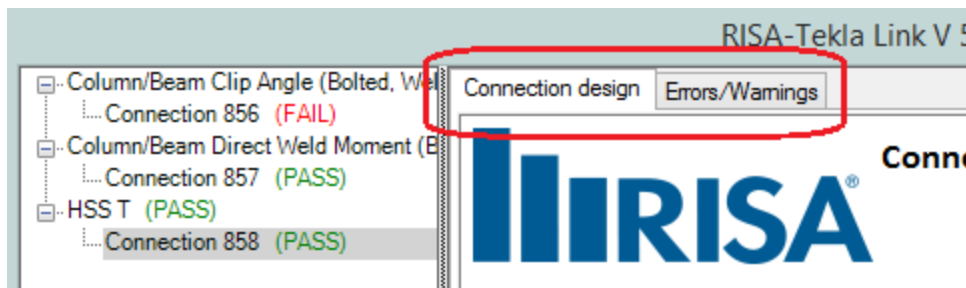

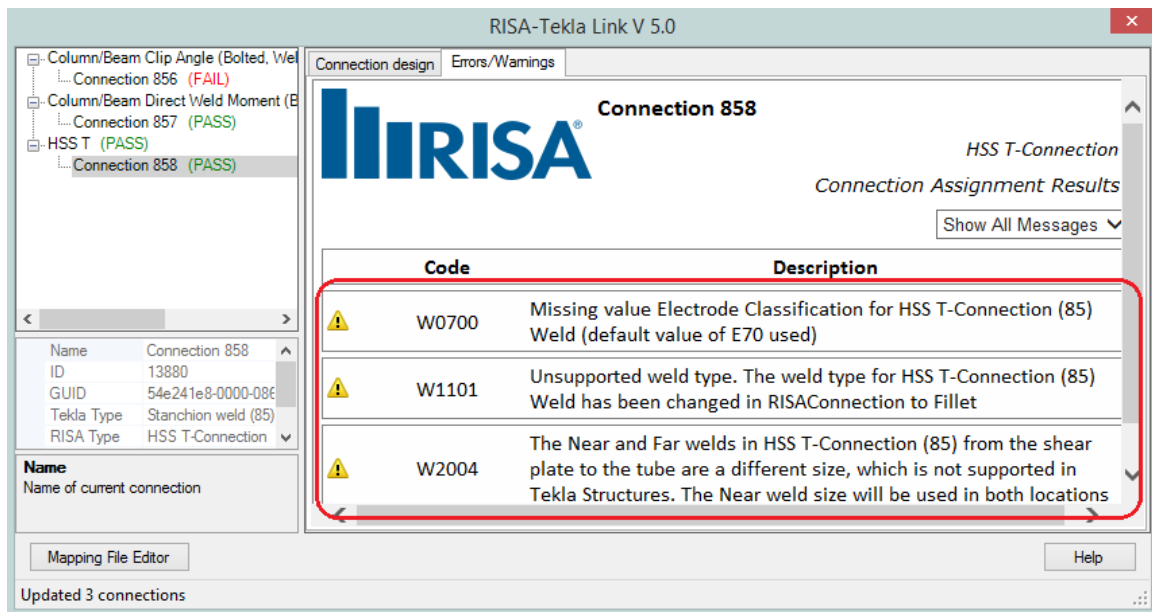

The **Connection design** tab will show each limit state and the corresponding Pass/Fail.

The **Errors/Warnings** tab will show warnings for any connection components that were not transferred, or give an error if the connection was not able to be transferred at all.

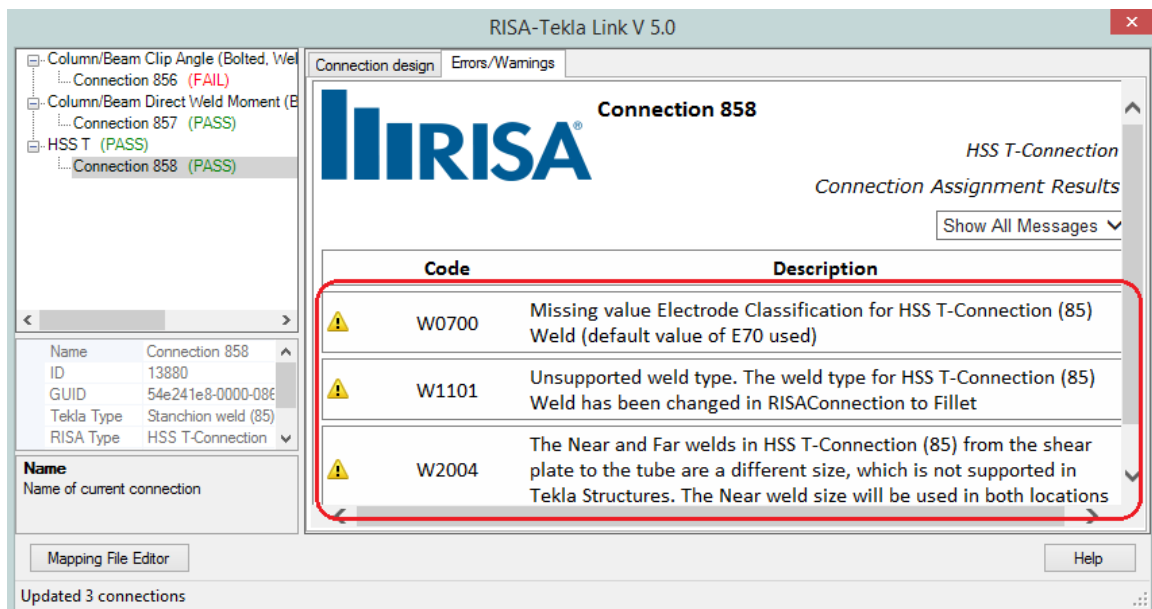

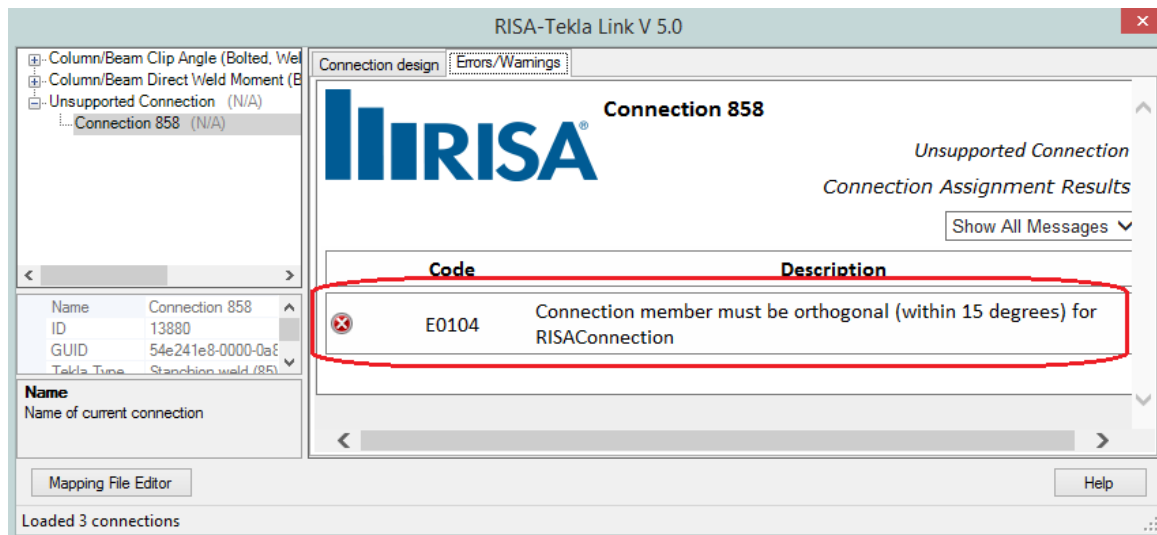
**Note:**

- There are many things that do not translate between RISAConnection and Tekla Structures. This in turn can cause either the connection to not go to RISAConnection, or some properties of the connection may not go to RISAConnection. For a list of these see the [Warning-Error Log](#) topic.

Graphical Results View

After the results are brought back into Tekla Structures the graphic view shows the connections by their color-coded results, green indicating a passing connection and red a failing connection.

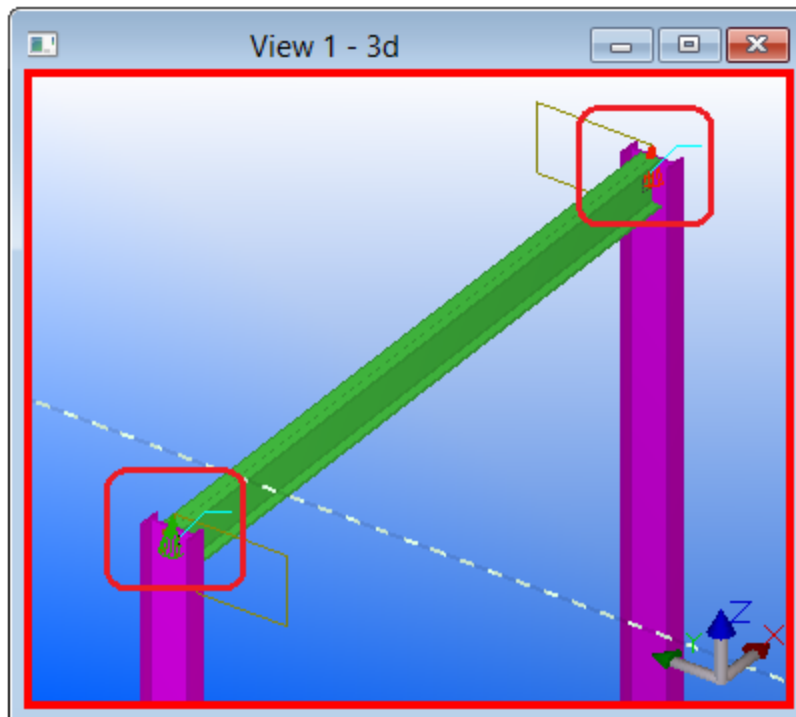
**Note:**

- This graphical results view is not available for all environments for all supported connections. This feature is also used in Tekla Structures, so there is conflicting functionality in certain cases.

Folder Structure

When the model is transferred to RISACONNECTION there are two files created in the directory of the Tekla file.

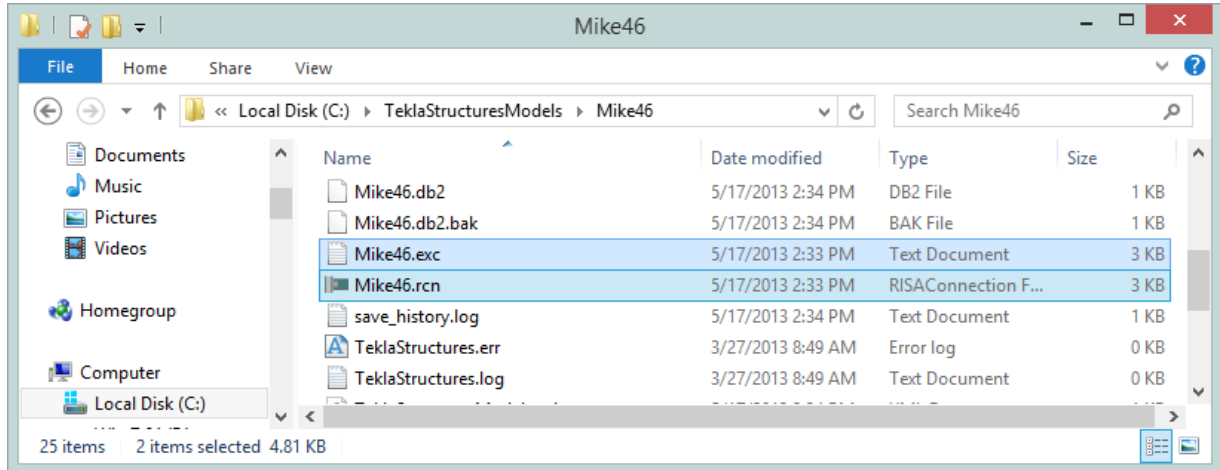

There is a ".exc" file and a ".rcn" file. The ".exc" file works as the exchange file between Tekla Structures and RISACONNECTION. The ".rcn" file is the RISACONNECTION input file. This prevents any information confusion in the link.

Registry and File Location Considerations

The RISA-Tekla Link relies on many different files to work properly. Information from Tekla Structures, RISACONNECTION and the RISA-Tekla Link itself is found by looking to either the registry directly, or to an INI file. Here is where we look for different items.

Note:

- The default location for each of these files will be in the default C:\RISA or C:\RISA\RISA Tekla Link folders. Only a catastrophic installation problem or manual editing of files and registry locations should break this functionality.

RISACONNECTION.exe

With the link we directly open RISACONNECTION. To do this we look for this RISACONNECTION.exe file from this location in the registry:

HKEY_LOCAL_MACHINE - SOFTWARE - Microsoft - Windows - App Paths - RISACONNECTION.exe

If the RISACONNECTION.exe is not located in this path then the link will not work properly.

TeklaLink.exe

Both running the RISA-Tekla Link in Tekla Structures AND sending information from RISACONNECTION back requires finding the TeklaLink.exe. We look in this location in the registry:

HKEY_LOCAL_MACHINE - SOFTWARE - Microsoft - Windows - App Paths - TeklaLink.exe

RISACONNECTION.ini

The RISACONNECTION.ini file gives the location where RISA's shape databases are located. The RISA-Tekla Link uses these shape databases to map Tekla Structures shape names to RISA shape names. Thus, the link needs to know where this file is located. It will look for the RISACONNECTION.ini from this location in the registry:

HKEY_CURRENT_USER - Software - RISA Technologies - RISACONNECTION - Version # - INI Path

TeklaLinkInfo.ini

The TeklaLinkInfo.ini gives the location where the RISA-Tekla Link mapping files are located. These mapping files are used to map the Tekla Structures shape names to the RISA shape names. It will look for the RISAConnection.ini from this location in the registry:

HKEY_CURRENT_USER - Software - RISA Technologies - RISATeklaLink - *Version #* - INI Path

RISACONNECTION-Tekla Link Integration Procedure

The RISA-Tekla link sends the geometry, connection loads, shape types and connection types automatically from Tekla Structures into RISACONNECTION. This allows you to design your connections in RISACONNECTION and then bring the results back into Tekla Structures to have your structure updated and to view the results.

Here we will walk through the steps required to design connections using this integration.

1. Completing the Tekla Structures Model

You must first model your structure in Tekla Structures, including the connections and the loading. RISA only supports specific connections with the RISA-Tekla link. This list can be found in the [Before You Begin](#) topic. If a connection is not one of these supported connections then it will show up as an **Unsupported Connection** in the RISA-Tekla link.

For information on loads see the [RISACONNECTION Behavior](#) topic.

2. Sending the Model to RISACONNECTION

After the model is completed in Tekla pressing the **RISA - Design Connections**  selection will open RISACONNECTION and all connections that are supported and selected will be brought in.

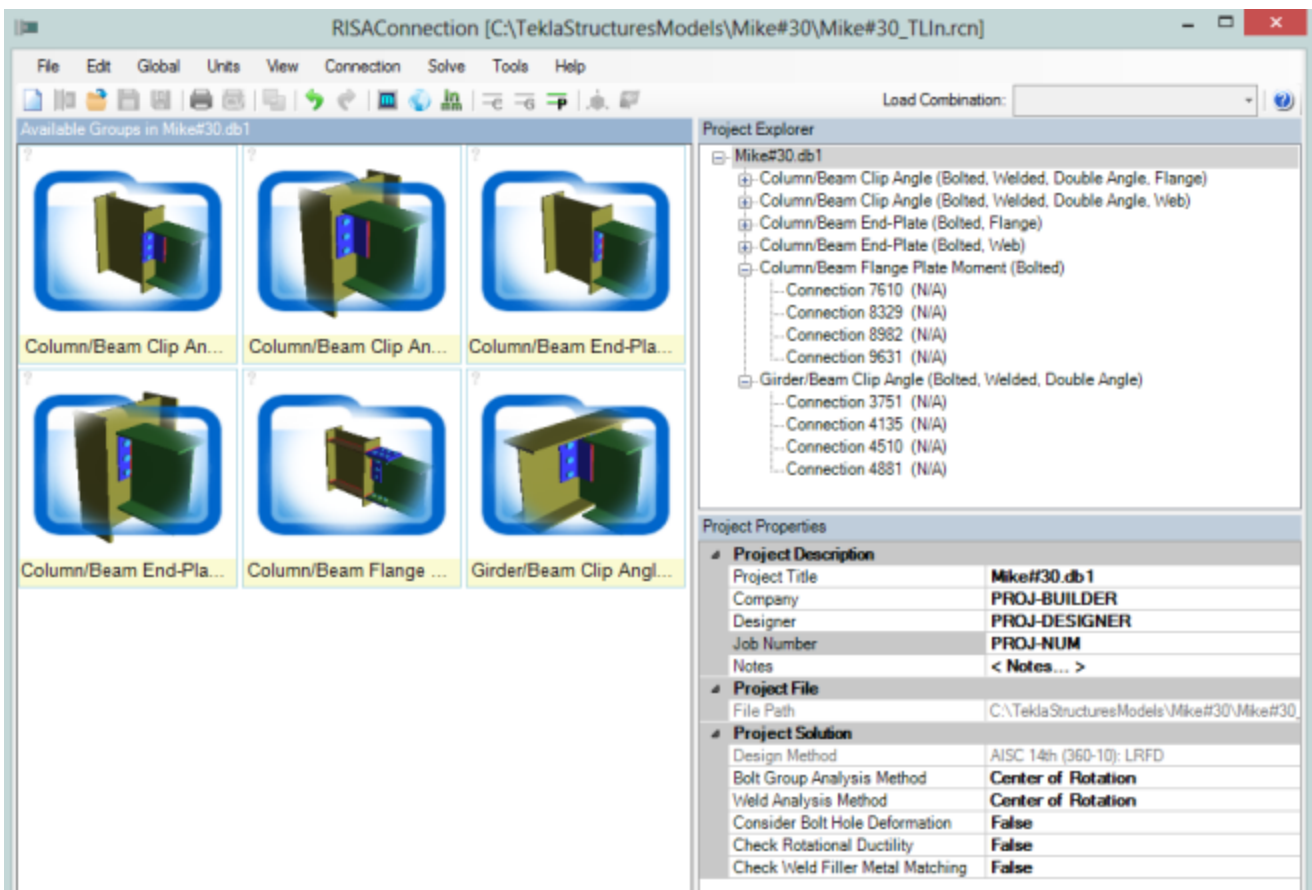

Any connections that are not brought in will be shown in the RISA Tekla Link window that becomes available as soon as the link is run.

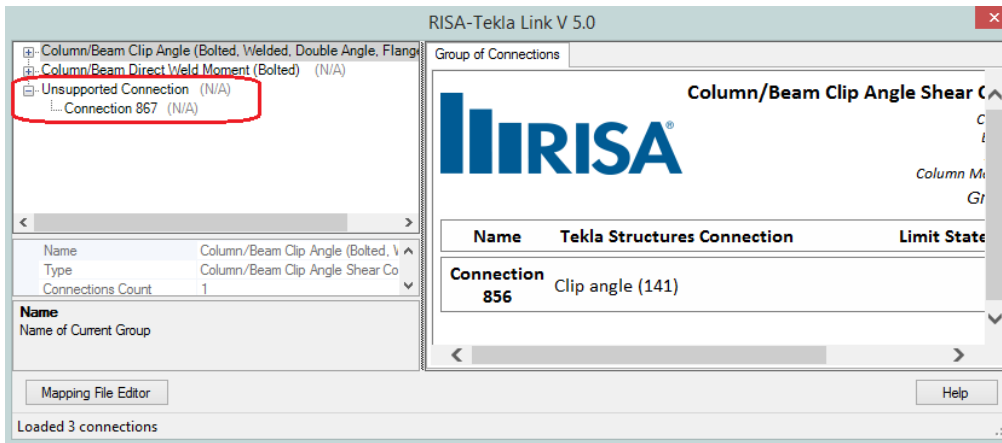

At this time the RISA-Tekla link will create a file with a .rcn extension in the model folder:

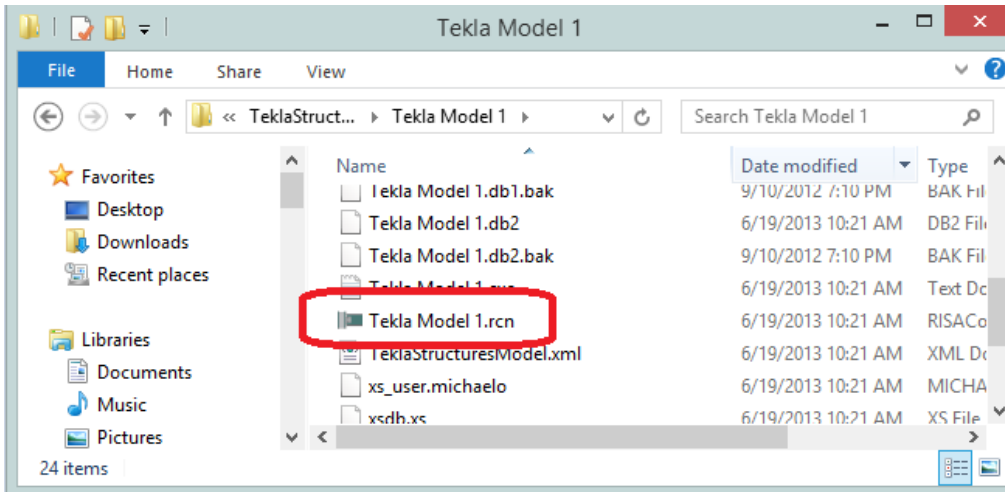

Note:

- By default all connections will be sent to RISAConnection. If there are specific connections you do not want to send to RISAConnection use the **RISA - Assign Connections**  selection and then choose the connections you wish to transfer from the list.

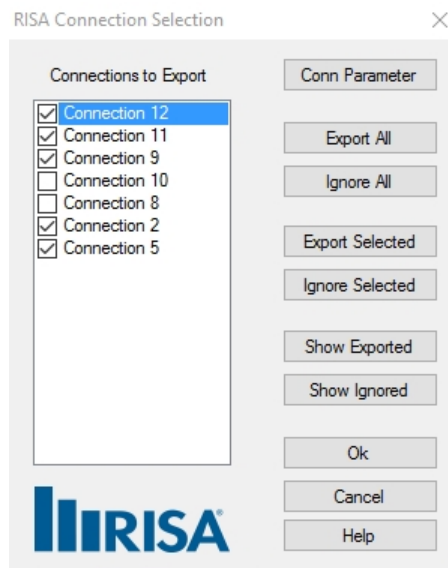

3. Configuring Connections and Solving in RISACONNECTION

In RISACONNECTION you can configure many of the properties of the connections using the RISACONNECTION interface. See the RISACONNECTION help file for more information on how the RISACONNECTION interface works.

Note:

- This configuring can be done directly on the machine where the integration was completed. This is the most straightforward approach. However, this can also be done on a separate machine. If you copy the .rcn file from the model folder directory you can then send that file to another RISACONNECTION user to edit/design the connections.



Once the configuring is complete you can then press any of the Solve buttons: **Project**, **Group**, or **Connection** to solve either a single **Connection**, **Group** or the entire **Project**. This will show a **Pass** or **Fail** for each of the connections and allow you to adjust properties to pass the connection.

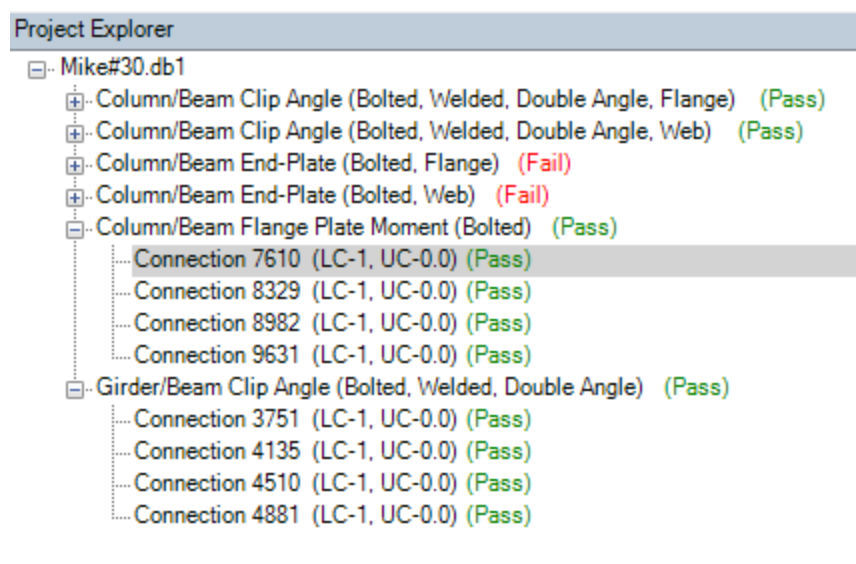



4. Connection Results Viewing/Updating in Tekla Structures

How you get back to Tekla Structures from RISACONNECTION is dependent on whether the connections were manipulated with RISACONNECTION on the same machine as Tekla Structures or on a different machine.

- If you have worked on RISACONNECTION on the same machine that you transferred from Tekla Structures:

- In RISACONNECTION, click the **Export to Tekla**  button to transfer back to Tekla Structures.

- If you worked on the RISACONNECTION file on a separate machine from the one running Tekla Structures:
 - Place the RISACONNECTION model file back (.rcn extension) in the Tekla Structures model directory.
 - Open the Tekla Structures model.
 - Press the **RISA - Show Results**  selection in Tekla Structures. DO NOT press the **RISA -**

Design Connections  **Export** button as this will overwrite your RISACONNECTION model again with the properties from Tekla Structures.

In either of the above cases this will do two things:

1. Open the RISA-Tekla Link results viewing dialog and show graphically whether a connection passes or fails.

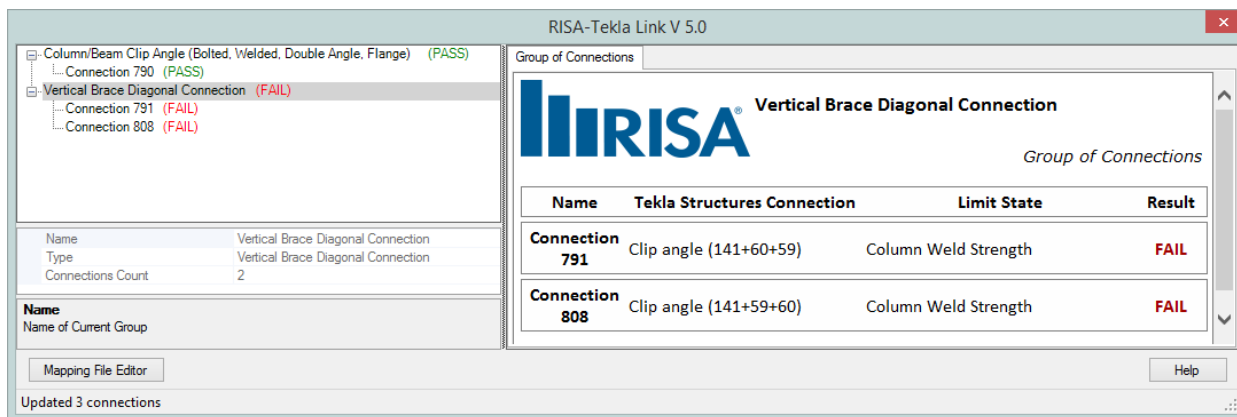

For more information on this dialog see the [Application Interface](#) topic.

A green cone indicates a passing connection:

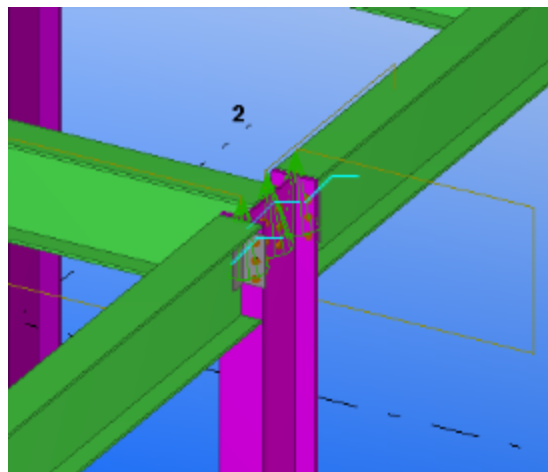

A red cone indicates a failing connection:

- Update the model for updates made in RISACONNECTION. This will physically change your Tekla model to match the RISACONNECTION component properties.

5. Automatic Roundtrip Solution Option



The **RISA - Roundtrip Design Connections** selection will do a full round trip between Tekla Structures and RISACONNECTION. Steps 2 through 4 would all be done automatically. This means that the model will be sent to RISACONNECTION, any applicable connections will be checked/solved in RISACONNECTION, and the model will then be exported back to Tekla Structures. Be very careful using this tool, as many changes can potentially happen to the Tekla Structures model that may not have been directly specified by the user. RISACONNECTION has limitations and these are imposed on the Tekla connections as well, which can cause automatic updates to the connection. This is NOT recommended for the first time solution in RISACONNECTION, as it will make many automatic changes with no real warning. However, if you have manually transferred to RISACONNECTION a few times and want a quick solution again then this button can be valuable.

Workflow Diagrams

If the Tekla Structures computer will also be using RISACONNECTION, use this workflow:

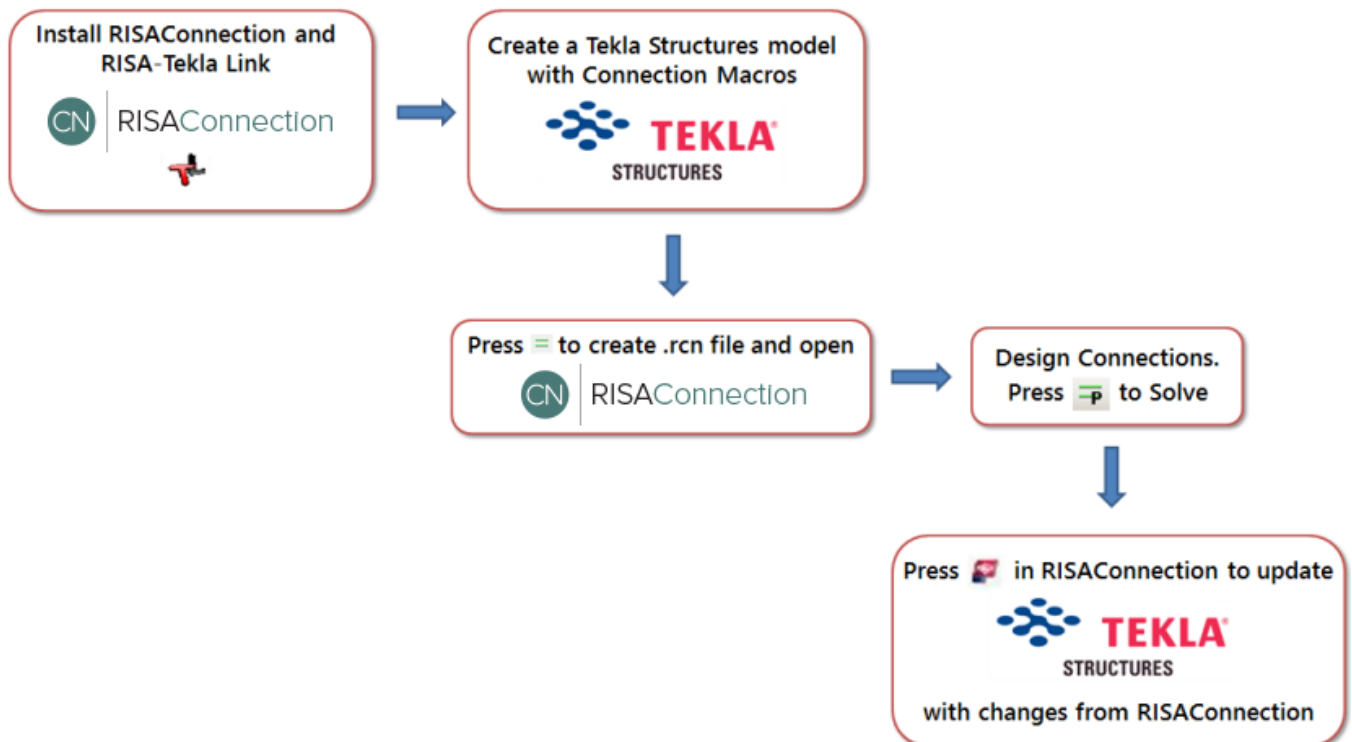

If the Tekla Structures computer will be different than the one using RISACONNECTION, use this workflow:

Phase 1: Export Tekla model

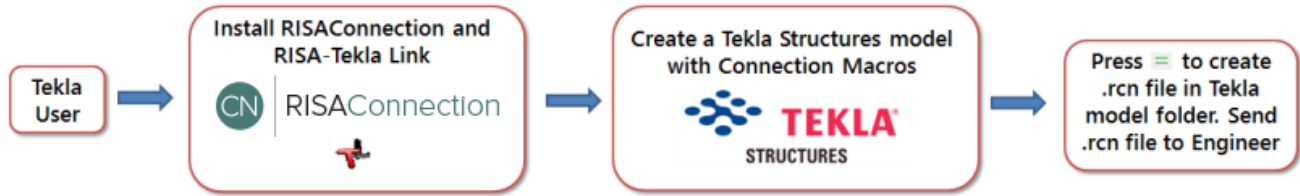

Phase 2: Design Connections



Phase 3: Import Changes to Tekla

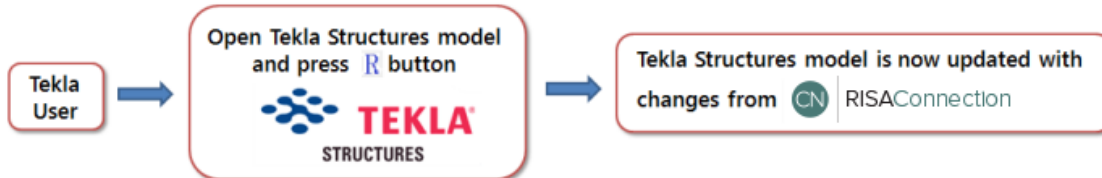

RISACONNECTION Behavior from a Tekla Structures Model

When transferring Tekla Structures connections to RISACONNECTION the majority of the behavior is similar to standalone RISACONNECTION. For this behavior view the RISACONNECTION General Reference which can be found on the Documentation page of our website at risa.com/d_documentation.html

This topic details specific variations from the standard RISACONNECTION behavior. To learn the steps of taking the Tekla Structures model to RISACONNECTION, view the [Tekla Connection Procedure](#) topic.

When first coming into RISACONNECTION from Tekla Structures you will see that the file is populated with all of the VALID connections. Thus, only connections that RISACONNECTION can actually design will be brought over. The act of invoking RISACONNECTION from Tekla Structures (using the  button) will create a RISACONNECTION file (with a .rcn extension) and a RISA-Tekla Link exchange file (with a .exc extension) and will be located in the same directory.

Connection Grouping

Once you have imported your information in RISACONNECTION, you will see that the connections are grouped in the **Project Explorer**.

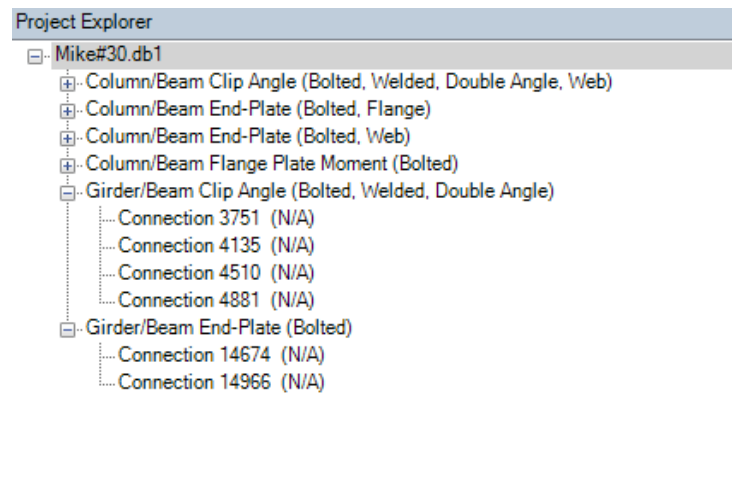

The groups in RISACONNECTION are based on the connection component numbers from within Tekla Structures. Within each Tekla Structures component connection, however, there are also groupings based on whether the members are framing into a column or beam, whether a column/beam connection frames into the web or flange of the column, what the shape type is, and so on. Therefore, a single connection component from Tekla Structures could create a large number of connection groups in RISACONNECTION.

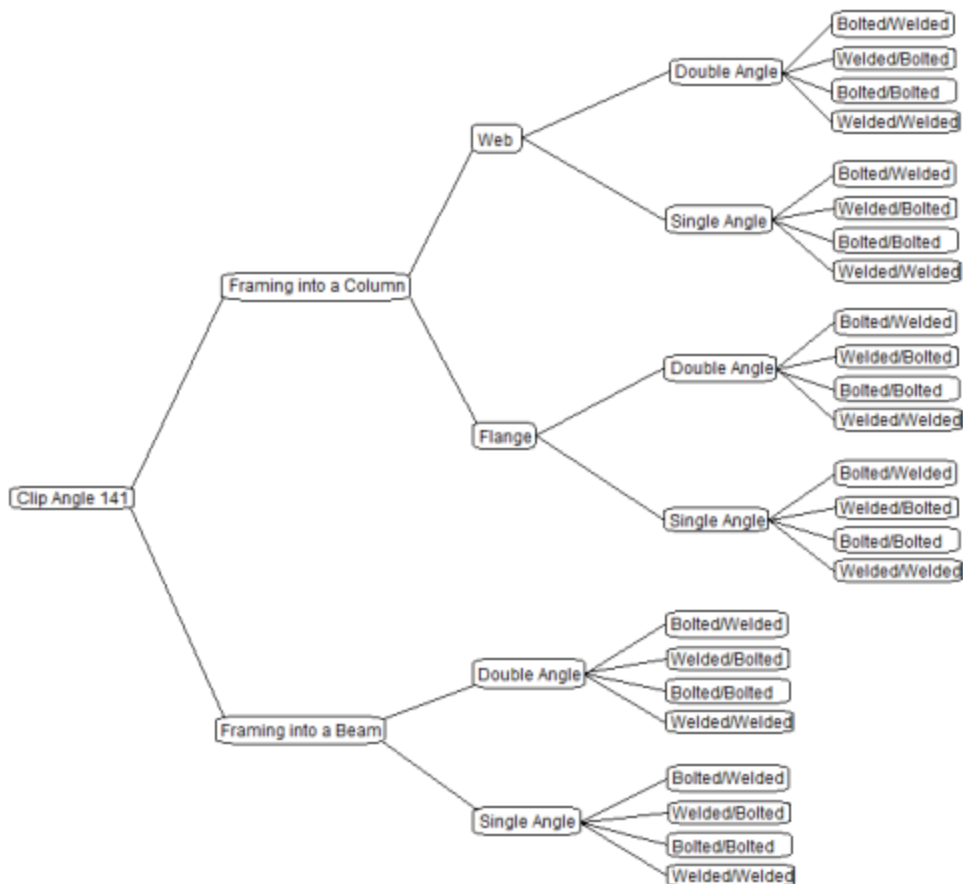

Grouping Behavior

In the Project Explorer there are three levels: Project level, Group level, and Connection level. These levels are nested within each other and allow you to change design and connection properties quickly and easily. There are also properties that can only be changed within Tekla Structures. Here we will discuss these different connection property categories and how to use them properly.

Tekla Structures Level

Items that can only be modified from Tekla Structures:

- Connection Types
- Connection Categories (bolted vs welded, single angle vs double angle, etc)
- Loading
- Member Shapes

If you wish to modify any of these properties you need to go back to the Tekla Structures model, make the change, and then re-export to RISAConnection.

Project Level

When you click the project label in the **Project Explorer**, the **Project Properties** are then shown.

Project Properties	
Project Description	
Project Title	Mike#30.db 1
Company	PROJ-BUILDER
Designer	PROJ-DESIGNER
Job Number	PROJ-NUM
Notes	< Notes... >
Project File	
File Path	C:\TeklaStructures\Models\Mike#30\Mike#30
Project Solution	
Design Method	AISC 14th (360-10): LRFD
Bolt Group Analysis Method	Center of Rotation
Weld Analysis Method	Center of Rotation
Consider Bolt Hole Deformation	False
Check Rotational Ductility	False
Check Weld Filler Metal Matching	False

Here you can update information in the **Project Description** fields and some of the options from the **Global Parameters - Solution** tab.

Note:

- When you click the Project in the **Project Explorer** the left screen shows all of the groups in the project and gives a representative view of each.

Group Level

When you click on a Group in the **Project Explorer** then the **Group Properties** are shown.

Group Properties	
Connection	
Connection Title	- Various -
Connection Type	Column/Beam End-Plate Shear Connector
Connection Category	
Column Connection	Bolted
Column Connection Type	Flange
Loading	
Shear Load, kips.	0.0000
Axial Load, kips.	0.0000
Top Column Dist, in.	0.0000
Column Force, kips.	0.0000
Story Shear, kips.	0.0000
Components	
Column Section	W16X50
Beam Section	W16X40
Plate Section	- Various -
Material	A36
Thickness, in.	- Various -
Width, in.	- Various -
Depth, in.	9.0000
Hole Type	STD
Column Bolts	- Various -
Beam Weld	E70
Assembly	
Plate Vertical Position, in.	1.1875

In the Group Properties you can modify connection properties for all of the connections within this group at one time. The grayed out properties are properties brought over directly from Tekla Structures; these properties can not be edited in RISACONNECTION.

Note:

- If you have changed individual connection properties and then go back to the group, changes here will overwrite any of those individual connection changes.
- When you click a Group in the **Project Explorer** the left screen shows all of the connections graphically in that group.
- If an item is labeled **-Various-** it means that there are multiple values in this field for the different connections in this group.

Connection Level

When you click on an individual connection, that connection's properties are shown.

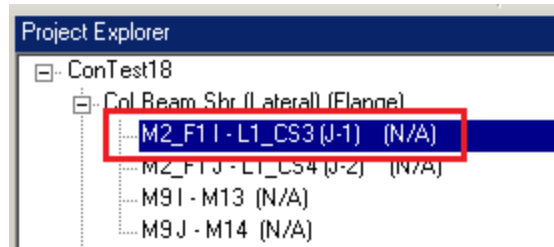

The grayed out properties within an individual connection may be either Tekla Structures controlled or Project level controlled. You must go up to those levels to change these properties.

Loading

Component Loads

RISAConnection accepts the Shear, Tension, and Moment fields for each connection. It will also accept a value in the **UDL %** field in place of the **Shear, V**. Please see the [UDL section](#) for more information on how this works.

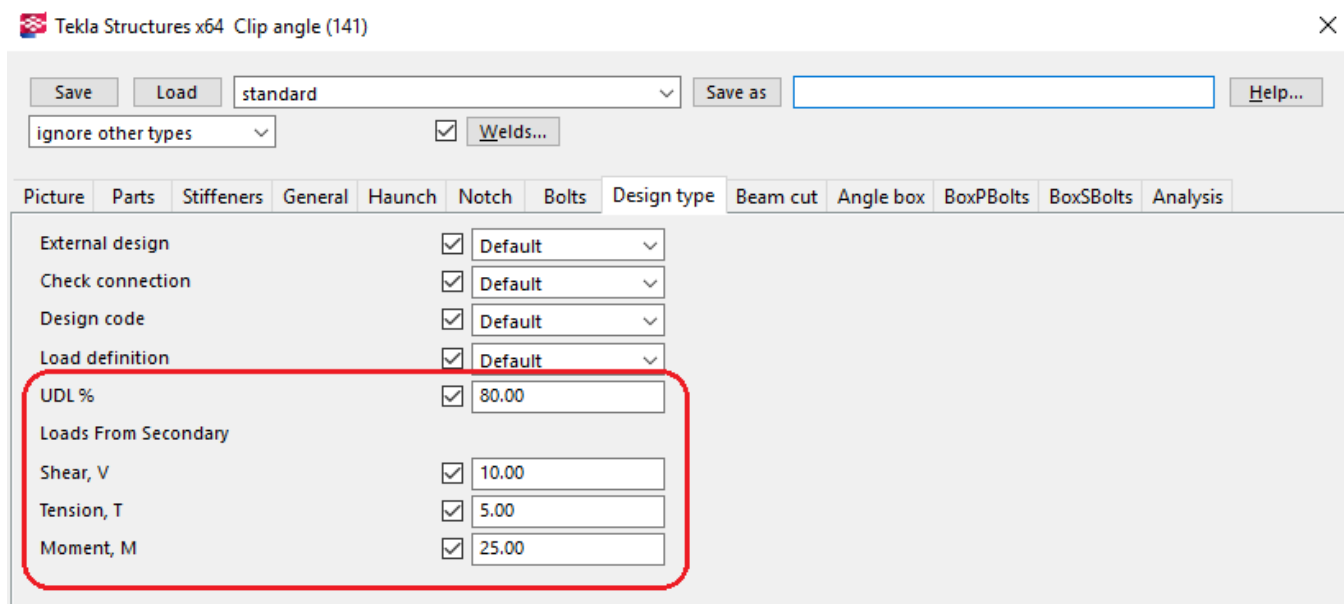

End Conditions

Double-clicking on a member and clicking the *User-defined attributes...* button and going to the **End Conditions** allows a user to define end reactions on a member. These end reactions will then be transferred to RISAConnection appropriately. Note that you can use the **UDL code** field in place of the **Shear, V_y (major)**. Please see the [UDL section](#) for more information on how this works.

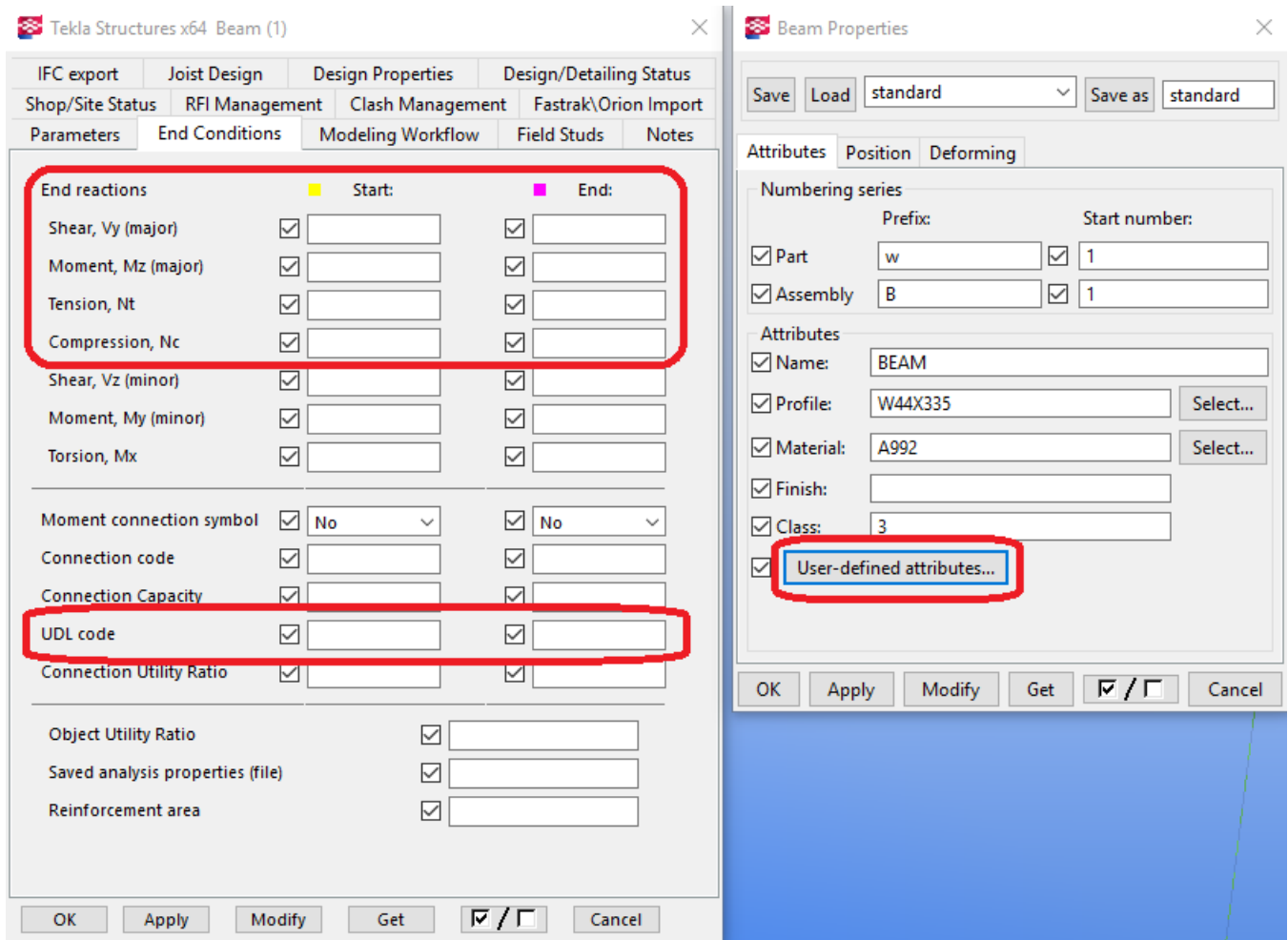
**Note:**

- If loading is applied to BOTH the component and the end reaction the Component value will be used.
- The **Column Force** and **Story Shear** values are not mapped from Tekla and must be entered manually once in RISAConnection.
- The Tension/Axial force value in Tekla is positive for tension. In RISAConnection, axial force is negative for tension. The RISA-Tekla Link will switch the sign of the force when transferring to account for this.
- Any loading that does not have an input in RISAConnection will not be considered in RISAConnection. Weak-axis shear and weak-axis moments are examples of this.

UDL % (Uniform Distributed Loads)

The UDL % is a way to have the link calculate the design shear forces on a beam in your model. This is done considering the AISC 14th edition manual Tables 3-6, 3-7, 3-8 and 3-9 for wide flanges and channels. These tables have a W_c/Ω_b for ASD and a ϕW_c for LRFD and units of kip-ft. Using the length, L, and the UDL % input the shear force calculation is as follows:

$$V_{ASD} = (\text{UDL } \%) * (W_c/\Omega_b) / 2L$$

$$V_{LRFD} = (\text{UDL } \%) * (\phi W_c) / 2L$$

This value is what will be brought into RISAConnection in the **Shear Load** field in RISAConnection.

Loading	
Shear Load, kips.	430.777
Axial Load, kips.	5.000
Top Column Dist, in.	0.000
Column Force, kips.	0.000
Story Shear, kips.	0.000

Note:

- UDL % is not supported for shapes other than wide flanges and channels in the AISC 14th edition manual.
- This field is only used for shear forces in beams and will be ignored if used in any other conditions.
- If a UDL % value is given in combination with a strong direction shear force (Vy, major) the program will use the shear force and ignore UDL %.
- The default code selected in RISAConnection is the **AISC 14th (360-10): ASD**, thus this initial transfer will always use the ASD value for the UDL % calculation. If you are using LRFD codes you'll need to edit this in RISAConnection and roundtrip the model to get back into RISAConnection with the proper loading.

Custom Loading in RISAConnection

RISAConnection allows you to use Custom loads that are not pulled from Tekla Structures. If you choose this option then the Tekla Structures forces will come in but the custom forces will be used.

Column Connection Type	Range
Loading	
Custom?	Yes
Shear Load, kips.	88.000
Axial Load, kips.	22.000
Top Column Dist, in.	-8.000
Column Force, kips.	0.000
Story Shear, kips.	0.000
Eccentricity Consideration	Both Connections

Solving Connections

Once you get the connections configured properly you need to solve the model. You can solve the model by con-



nection, by group or for the entire project by pressing the appropriate button to solve either a single **Connection**, **Group** or the entire **Project**.

Note:

- If you are using RISAConnection as a standalone program then these solve buttons have no use because the model is re-solved automatically each time a change is made.

Viewing Results (in RISAConnection)

Once you have a connection, a group, or the entire project solved you will be able to view results via the **Project Explorer** or **Reports** tab.

Project Explorer

The **Project Explorer** gives a summary of the design results for the project. Each connection gives a Pass or Fail notification, along with the Max UC and the LC that produced it.

The Group will state "Pass" if all of the connections within the group passes. It will state "Fail" otherwise.

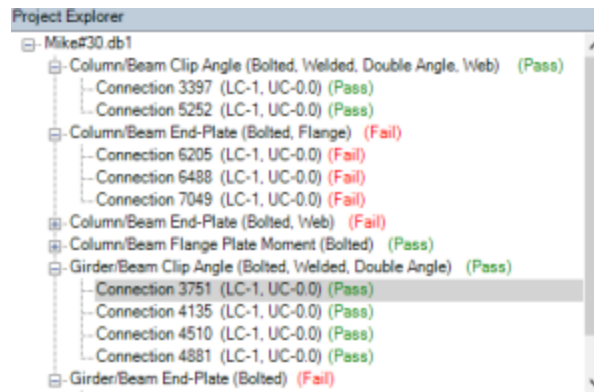

If a property is changed then the connections whose properties are affected will be invalidated. If you modify a single connection then the results for that connection will be invalidated and an (N/A) will be shown.

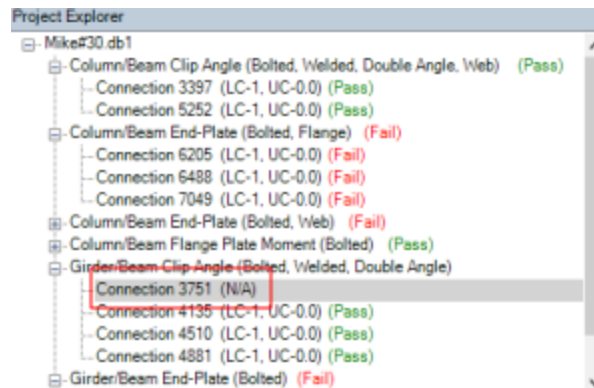

In this scenario you can simply re-solve that connection to get results again.

If you invalidate a group property then that will invalidate all of the connections within that group. If you invalidate a project property, then it will invalidate all connections in the project.

Reports

The **Report** view gives the unity checks for each Limit State. value. The **Reports** section will show which Limit State produced this value.

LRFD Results Members Components

RISA Connection 857 LRFD

Column/Beam Direct Weld Moment Connection
Connection design

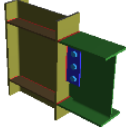

Material Properties:				
Column	W16x50	A992	F _y = 50.00 ksi	F _u = 65.00 ksi
Beam	W16x40	A992	F _y = 50.00 ksi	F _u = 65.00 ksi
Plate	P0.38x3.75x9.00	A36	F _y = 36.00 ksi	F _u = 58.00 ksi
Transverse Stiffener	P0.38x3.35x15.04	A36	F _y = 36.00 ksi	F _u = 58.00 ksi

Input Data:		
Shear Load	0.00 kips	User Input Shear Load
Moment	0.00 kips-in	User Input Moment
Axial Load	0.00 kips	User Input Axial Force
Puf_c	0.00 kips	Required Flange Force (compression)
Puf_t	0.00 kips	Required Flange Force (tension)
Top Column Dist	-0.00 in	User Input Top Column Dist
Column Force	0.00 kips	User Input Column Force
Story Shear	0.00 kips	User Input Story Shear

Note: Unless specified, all code references are from AISC 360-10 Collapse All Expand All

Limit State	Required	Available	Unity Check	Result
Geometry Restrictions at Beam				
				PASS
Column Weld Limitations				
				PASS
Beam Web Shear Yield	0.00 kips	123.43 kips	0.00	PASS
Plate Shear Yield	0.00 kips	72.90 kips	0.00	PASS
Beam Web Shear Rupture	0.00 kips	96.93 kips	0.00	PASS
Plate Shear Rupture	0.00 kips	62.40 kips	0.00	PASS
Bolt Bearing at Beam Web	0.00 kips	53.68 kips	0.00	PASS
Bolt Bearing at Shear Plate	0.00 kips	53.68 kips	0.00	PASS
Bolt Shear at Beam Web	0.00 kips	53.68 kips	0.00	PASS
Column Weld Strength	0.00 kips	75.17 kips	0.00	PASS

If the connection you are viewing has its results invalidated by changing a connection property, then this message will be shown:

Report not calculated. Press here for Calculation!

If this message is shown then the results shown are invalid. Pressing this message has the effect of solving that individual connection. The program will then give valid results for this connection.

Viewing Results (in Tekla Structures)

Once you have your connections configured properly you can take those results back to Tekla Structures to be

viewed in the **RISA-Tekla Link** browser and graphically by pressing the  button in RISACONNECTION.

This will do two things:

1. Open the RISA-Tekla Link results viewing dialog and show graphically whether a connection passes or fails.

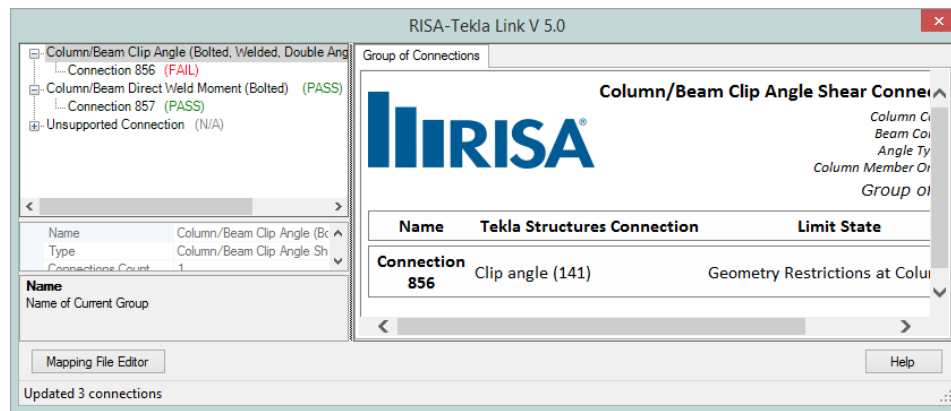

For more information on this dialog see the [Application Interface](#) topic.

A green cone indicates a passing connection:

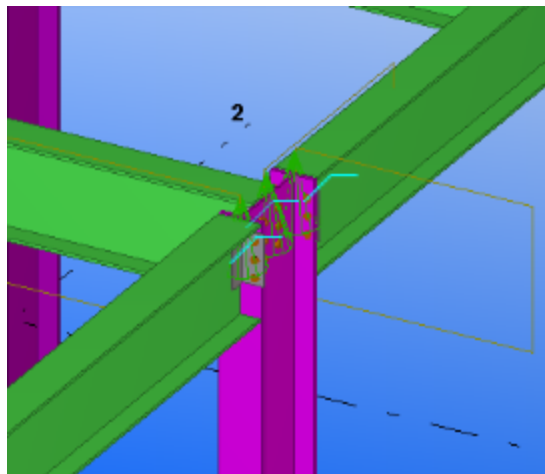

A red cone indicates a failing connection:

2. Update the model for updates made in RISACONNECTION. This will physically change your Tekla Structures model to match the RISACONNECTION properties.

Round-tripping between Tekla Structures and RISACONNECTION

The Tekla Structures and RISACONNECTION integration is meant to be used for multiple round-trips. You can go back and forth as many times as necessary to complete your project. See the [Workflow Diagrams](#) section for more information on this.

Note also that there is the  button that will automatically roundtrip the model from Tekla Structures through RISACONNECTION and back to Tekla Structures. This is NOT recommended for the first time solution in RISACONNECTION, as it will make many automatic changes with no real warning. However, if you have manually transferred to RISACONNECTION a few times and want a quick solution again then this button can be valuable.

Component Specific Considerations

When transferring Tekla Structures connections to RISAConnection properties are mapped over from Tekla Structures to RISAConnection and vice-versa. Tekla Structures and RISAConnection are very different and were built for different applications. Because of this there are items that don't map exactly as you might expect. Here we will elaborate on some of these items.

Vertical Brace Connection Considerations

Requirements to Transfer the Connection

For vertical brace connections, the RISA-Tekla Link allows the transfer of Components 141 or 146 (beam-to-column) in combination with Components **Wraparound Gusset (58)**, **Hollow brace wraparound gusset (59)** or **Wraparound gusset cross (60)** (brace to beam-column intersection). This connection will come over as the Vertical Brace Diagonal Connection in RISAConnection.

For this transfer to work, some basic requirements must be met:

- The beam and column shapes must be Wide Flanges and intersect at ~90 angles.
- The brace must be a tube or pipe (slotted around gusset connection), single angle, double angle or WT for Component **Wraparound gusset cross (60)**.
- The brace must be a tube or pipe (knife plate connection) for Component **Hollow brace wraparound gusset (59)**.
- The brace must be a wide flange for Component **Wraparound Gusset (58)**.
- The brace must form an angle between 10 and 80 degrees between the beam and column.

Beyond these requirements there are more specific items that must be set properly on the component to perform the transfer:

1. The gusset-to-beam and gusset-to-column connection must be explicitly defined from the **Gusset** tab of the component. RISAConnection only supports double angle and direct welded connections. Any other selection will not work.

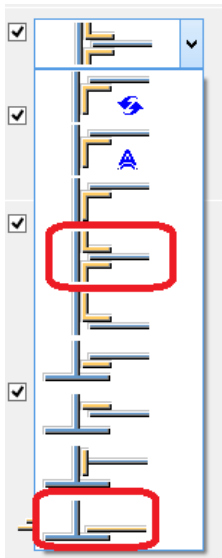

2. The gusset-to-beam and gusset-to-column connection must also be defined explicitly on the **Gusset conn 1** and **Gusset conn 2** tabs, unless BOTH connections are the same.

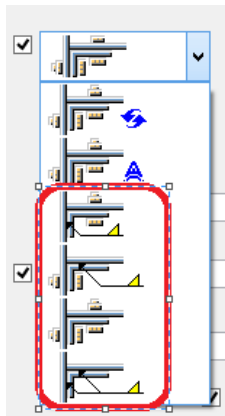

- 3. If a weld is defined you must be sure to have the weld also defined from within the **Welds...** dialog.

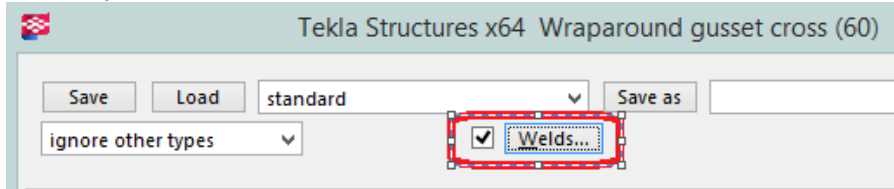

Other Vertical Brace Considerations

Multiple Braces Coming into the Same Joint

There is a potential for one, two, three or four braces to come into a single column/beam joint. In RISAConnection only a single "side" of the column is considered for an individual connection. If four braces come in this will be split into two separate connections for the two sides of the connection.

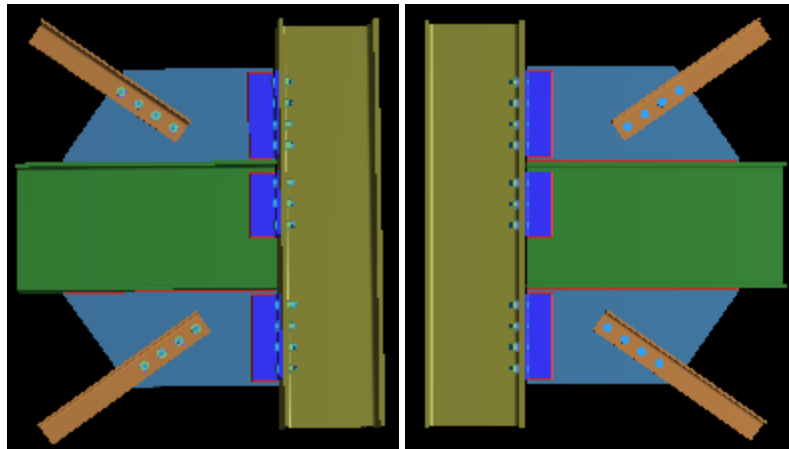

From here the RISA-Tekla Link determines the eccentricity of the braces. RISAConnection has three categories: **Concentric**, **Along Beam**, **Along Column**. Thus, the link will calculate the workpoint locations for the braces/-beam/column to see how they line up and then group them accordingly.

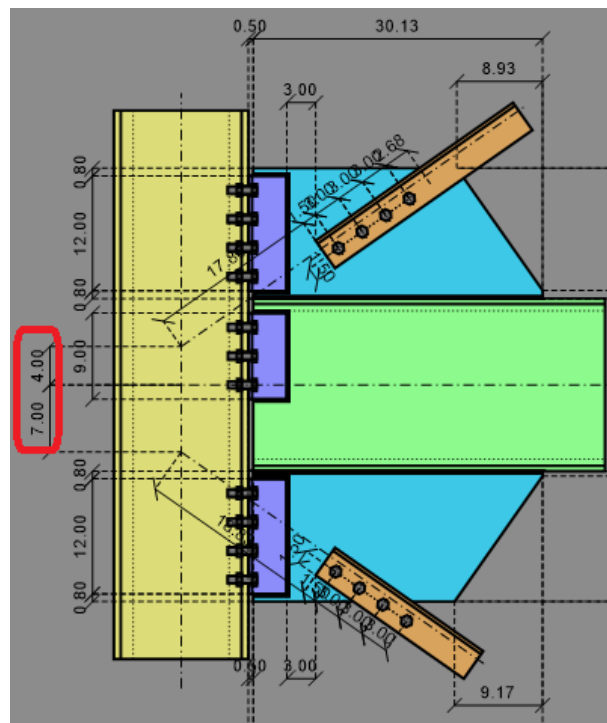

For the **Concentric** case if the beam/column, top and bottom workpoints all hit concentrically it will come over as concentric. If both the top and/or bottom braces are eccentric from the beam/column workpoint by ≤ 2 " then the program will bring this connection in as concentric.

If braces are eccentric >2 " and workpoints for both top and bottom braces don't land on the same element (beam or column) then this connection will be unsupported.

Double Angle Braces

Tekla Structures does not have a single shape element for double angles. To create a double angle configuration in Tekla Structures you must either explicitly draw two angles.

For double angle braces to be supported in RISAConnection they must:

- Be the same angle and the same orientation for both.
- Be parallel to one another
- Be explicitly part of the component creation (click beam, first angle brace, second angle brace, column, create)

Note:

- When a double angle is used in RISAConnection the default shape will always have a 3/8" gap. In reality the gap may be different but this gap has no effect on the calculations in RISAConnection, so it is not directly mapped.

Regarding loading of double angle braces the program will sum the loads from **Loads from Secondary 1** and **Loads from Secondary 2** and bring that total to RISAConnection.

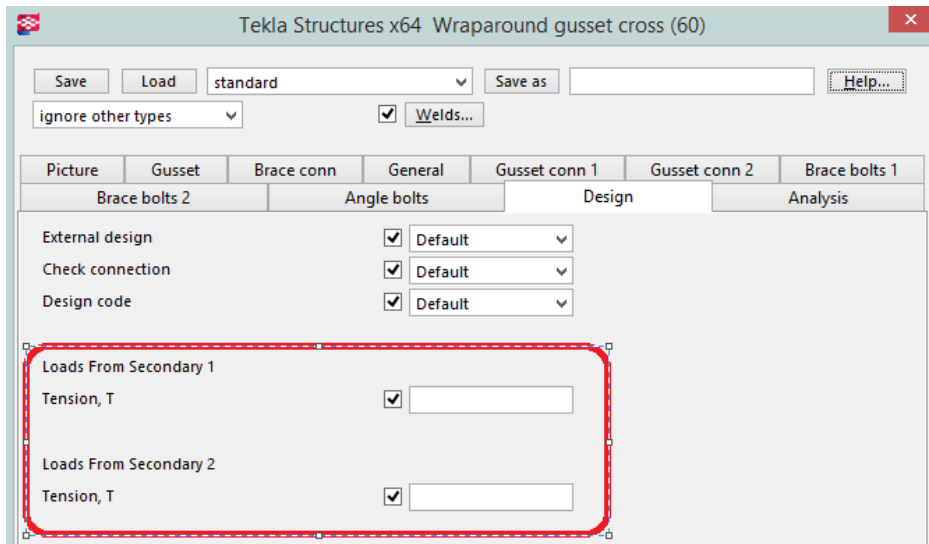

Gusset Positions

In RISAConnection, the distances on either side of the gusset clip angles are always the same. Thus, if unequal distances are given in Tekla Structures the program will take the average of these values and use them for both sides of the gusset.

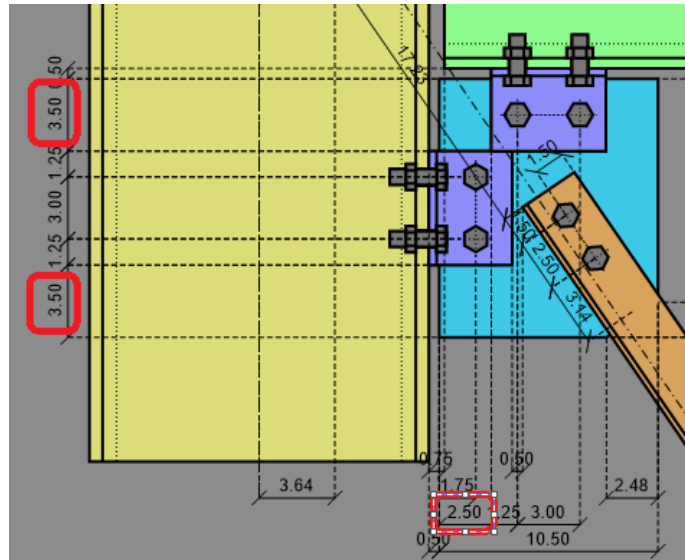
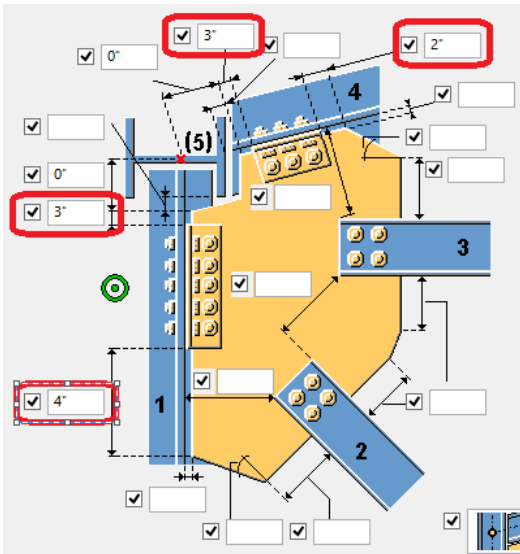

Gusset Clip

Tekla Structures and RISAConnection do not have a matching dimension for the gusset clip. However, these dimensions are used to transfer the clip.

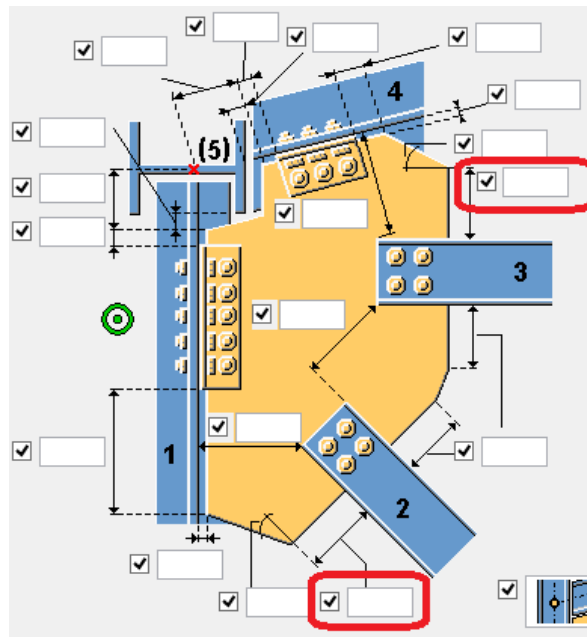

These two dimensions are added together with the width and angle of the brace and used to determine the Gusset Clip in RISAConnection.

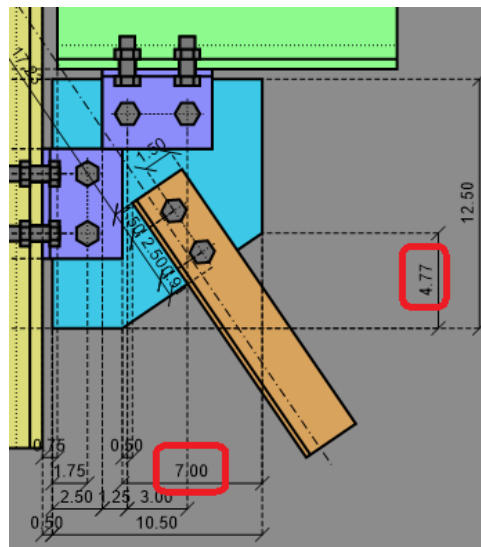

Brace Minimum Clearance

RISAConnection and Tekla Structures have similar inputs for this value.

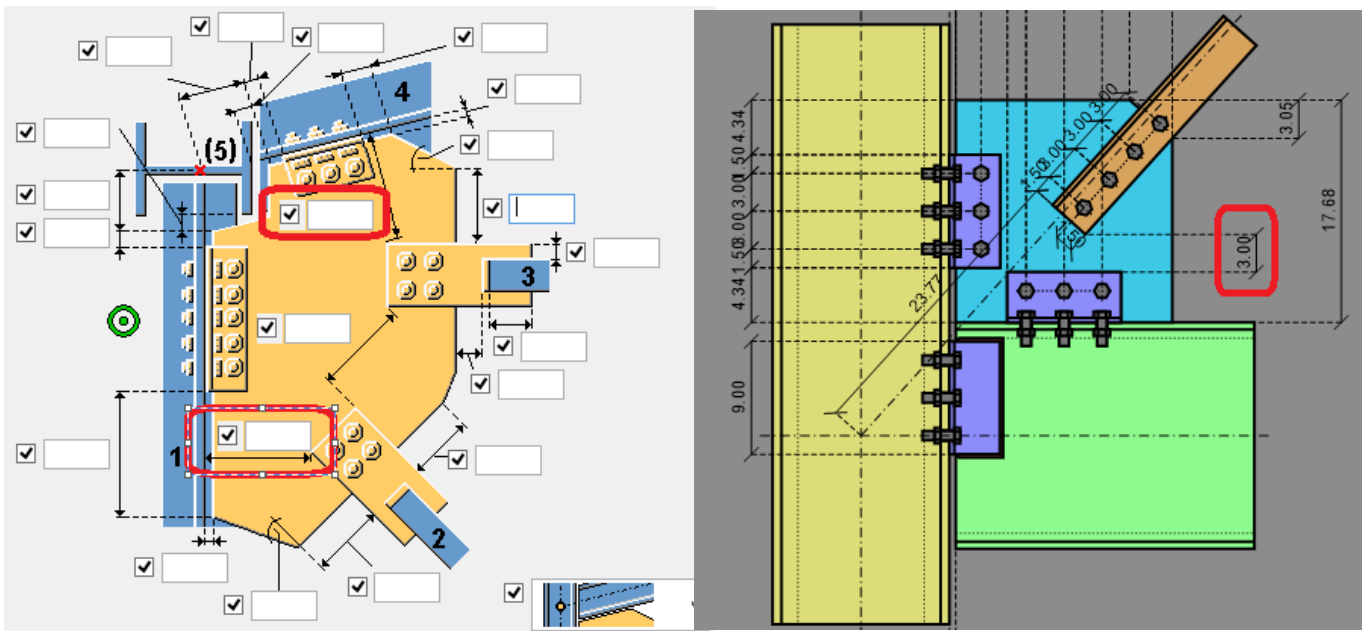

However, we can see in Tekla Structures that the dimension goes directly to the face of column and in RISAConnection this is dimensioned to the connector. This is accounted for in the RISA-Tekla Link.

Chevron Brace Connection Considerations

Requirements to Transfer the Connection

For chevron brace connections, the RISA-Tekla Link allows the transfer of Components **Bolted Gusset (11)** and **Tube Gusset (20)**. This connection will come over as the Vertical Brace Chevron in RISAConnection.

For this transfer to work, some basic requirements must be met:

- The beam shape must be a Wide Flange, Tube or Pipe.
- The brace must be a tube or pipe (slotted around gusset connection), single angle, double angle or WT for Component **Bolted Gusset (11)**.
- The brace must be a tube or pipe (knife plate connection) for Component **Tube Gusset (20)**.
- The brace must be a wide flange for **Component Gusseted cross (62)**.
- The brace must form an angle between 10 and 85 degrees between the beam and column.

Beyond these requirements there are more specific items that must be set properly on the component to perform the transfer:

1. The gusset-to-beam and gusset-to-column connection must be explicitly defined from the **Gusset** tab of the component. RISAConnection only supports double angle and direct welded connections. Any other selection will not work.

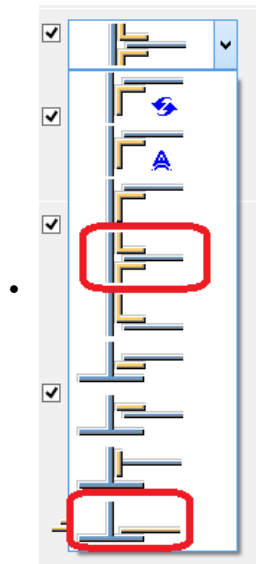

2. The gusset-to-beam and gusset-to-column connection must also be defined explicitly on the **Gusset conntab**.

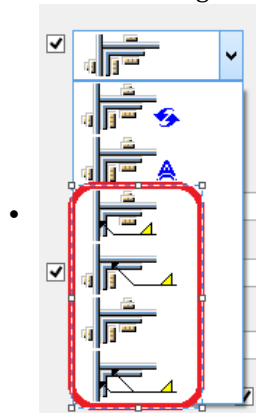

3. If a weld is defined you must be sure to have the weld also defined from within the **Welds...** dialog. The only welds supported are shown below:

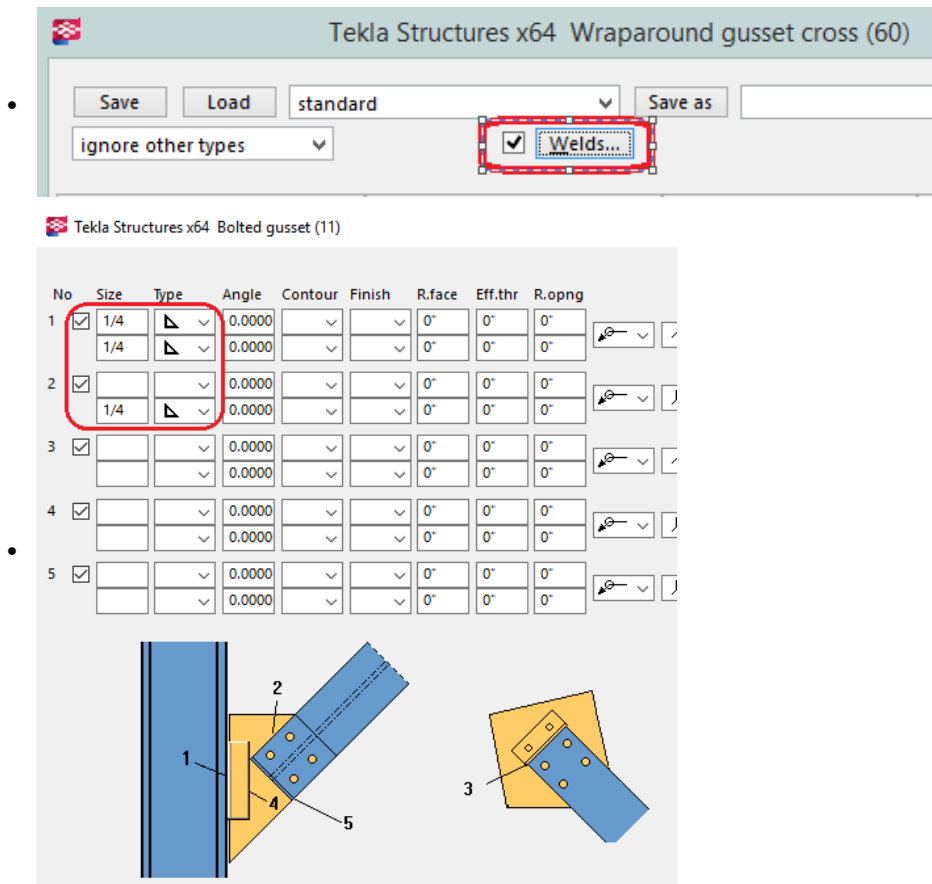

Note:

- In Tekla Structures if you define a weld it will be defined on both braces. RISAConnection standalone will allow you to have different connections on each brace. Thus, when using the RISA-Tekla Link you must have the same fastener type (welds or bolts) on both braces.

Connection Orientation for K-Brace Situations

Chevron braces are integrated whether they frame into a beam or a column. For beam framing it is relatively easy to understand the front of the brace and how mapping should occur.

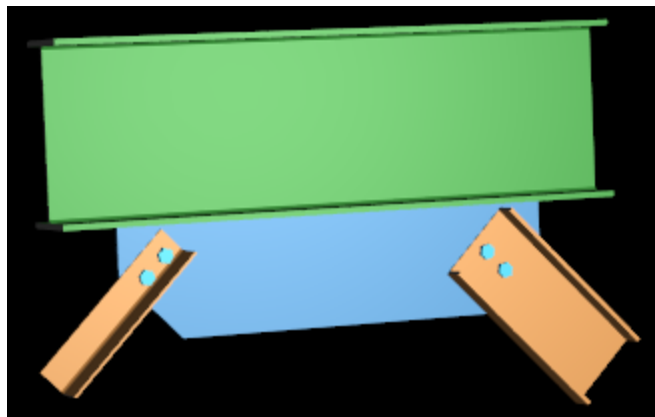
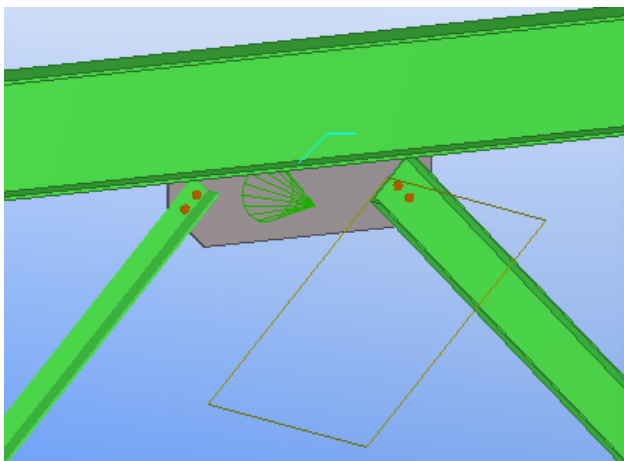

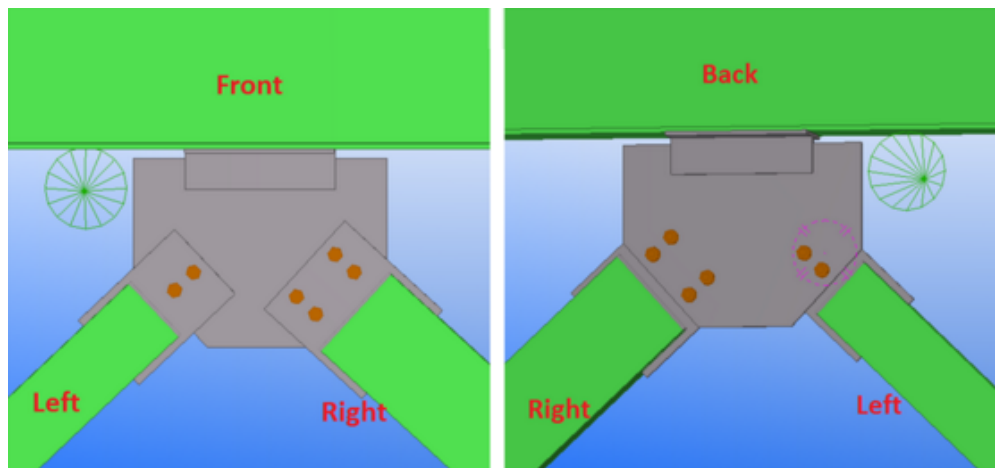

However, for columns the orientation is more complex. Here's how it works:

- If the connection is built from one column and two braces then the connection will always come over in the below the beam configuration, rather than above.

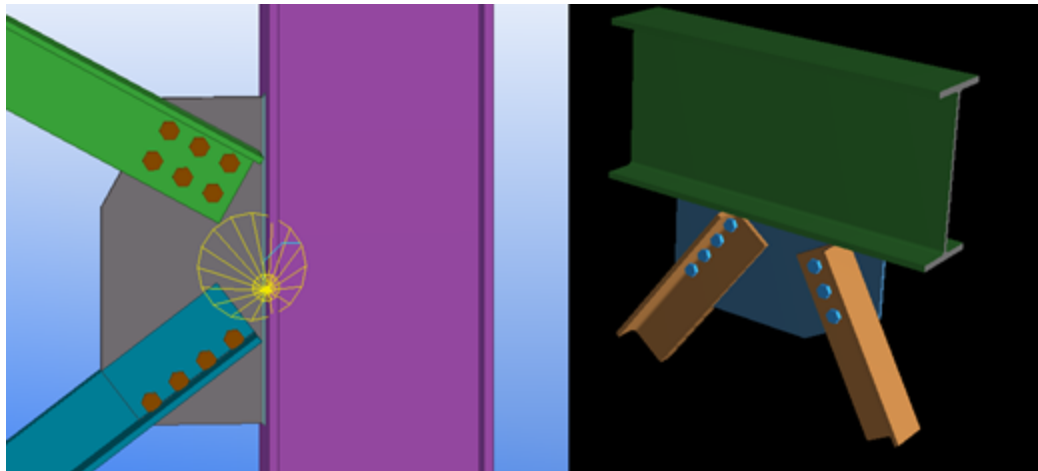

- The left and right brace is determined by using the coordinate system of the connection (in the direction of the cone)

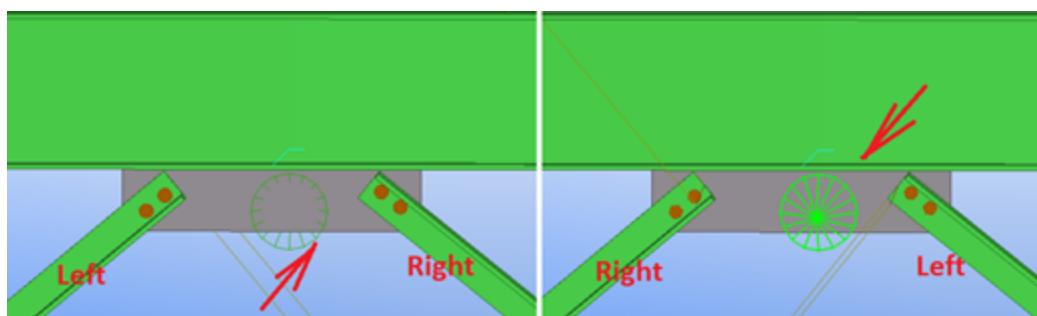

- If one or more of brace has an asymmetrical shape relative to the gusset (Angle, T-shape, C-shape) then the orientation of this brace determines the front side of the connection. In this case left and right brace are determined by the front side of connection.

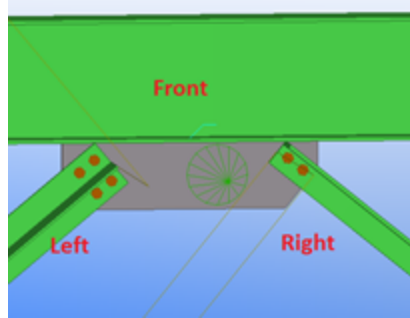

- If both braces have an asymmetrical shape relative to the gusset (Angle, T-shape, C-shape) AND braces are oriented in different directions then the front side of connection can not be determined. In this case the connection will not be transferred to RISAConnection.

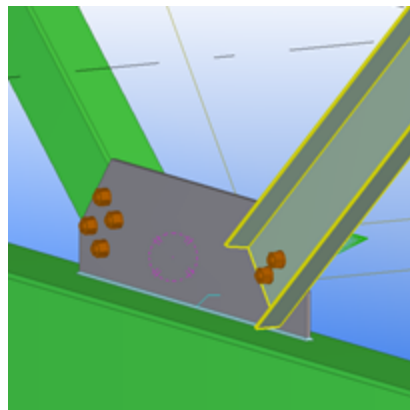

Single Base Plate Connection Considerations

For single column base plate connections, the RISA-Tekla Link allows the transfer of Component **US Column Base Plate (1047)**. This connection will come over as the single column base plate connection in RISAConnection.

For this transfer to work, some basic requirements must be met:

- The steel column must be a wide flange, HSS tube, or HSS pipe shape and in a vertical orientation.
- The base plate connection component must be assigned to the bottom of the column member.
- The column must be centered on the base plate.
- The anchor bolt pattern must be centered on the base plate.
- The base plate must be rectangular.
- The concrete support must be rectangular and may not be smaller than the steel base plate.

Beyond these requirements there are more specific items that must be set properly on the component to perform the transfer:

Base Plate

The base plate profile must be rectangular. The base plate dimensions and material are mapped with the following options below:

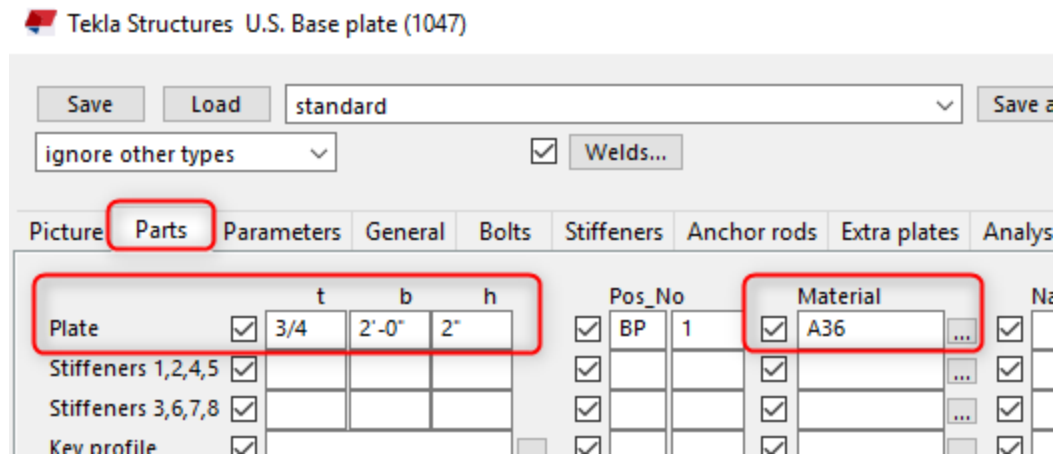
**Note:**

- t = plate thickness
- b = plate width, if blank Tekla assumes width is 1.25*Column Flange Width.
- h = plate length, if blank Tekla assumes length is 1.25*Column Depth.
- Key profile, leveling plates, and fitting plates are not supported in RISAConnection so these options will not transfer to RISAConnection.
- Tapered base plate corners will be ignored during transfer.

Concrete Support

The material strength for the concrete support may be defined under the Anchor Rod tab under the option boxed below.

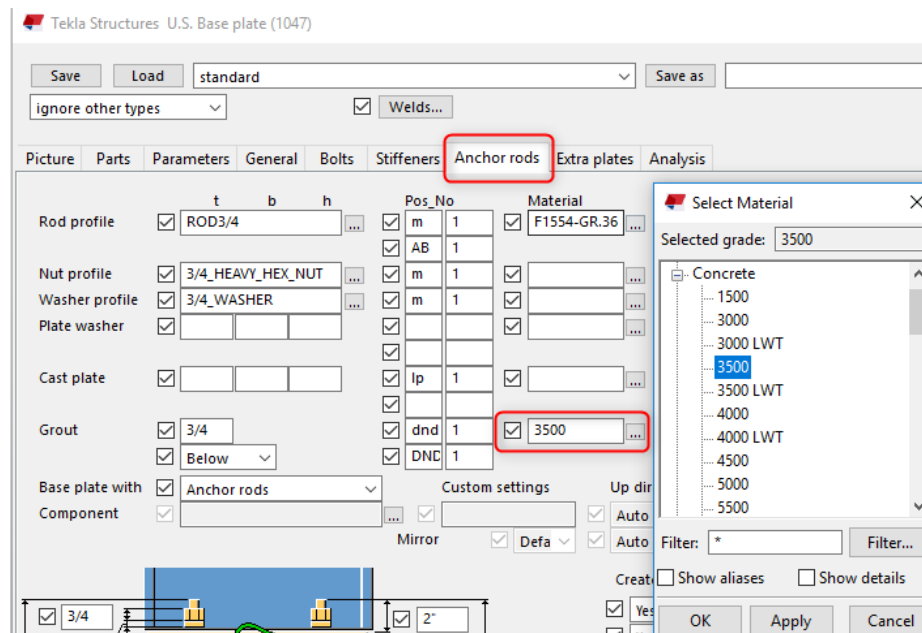

The concrete support dimensions are not available in Tekla Structures, so the user will have control over these inputs in RISAConnection. During the initial transfer the concrete lengths and widths will assume 1.5*Column Depth/ Width respectively.

Anchor Bolts

The anchor bolt diameter and material may be selected from the following options below:

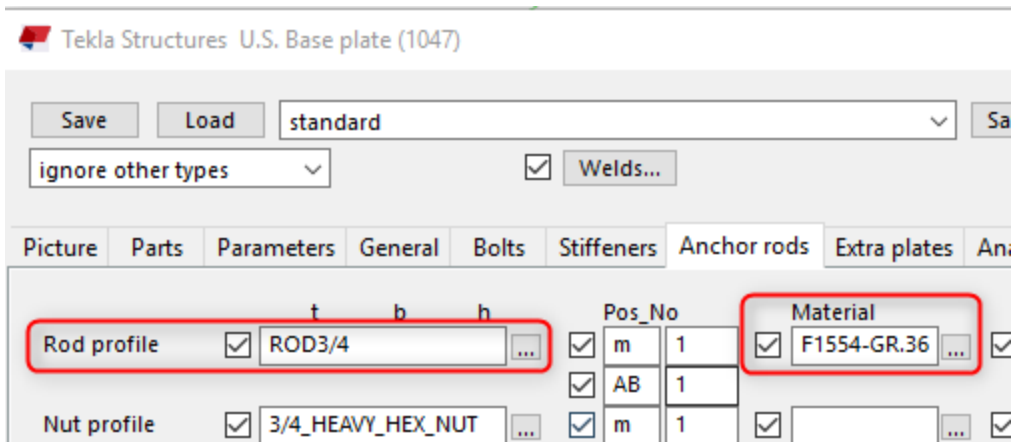

RISAConnection supports the following bolt layouts:

- Four - This option defaults to one bolt at each corner of the plate.

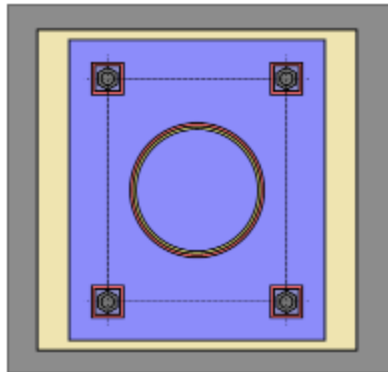

- Six - This option defaults to three bolts on two opposite sides of the plate. The user can indicate whether the bolts go on the "Strong Axis" or "Weak Axis" using the Layout Option entry.

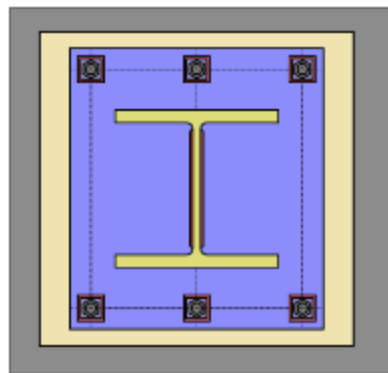

- Eight - This option defaults the eight bolts equally around each side of the plate.

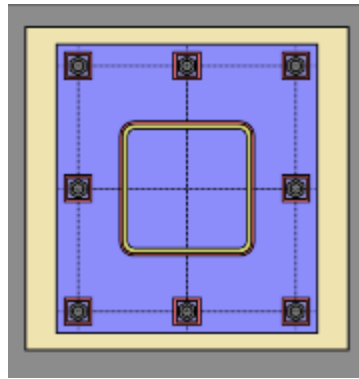

The edge distance in RISACONNECTION is mapped to Tekla's bolt edge distance to shim plate. When this input is blank, a default value of 30mm or 1.18in is used.

Tekla Structures U.S. Base plate (1047)

Save Load standard

ignore other types Welds...

Picture **Parts** Parameters General Bolts Stiffeners Anchor rods

	t	b	h	Pos_No	Mat
Plate	<input checked="" type="checkbox"/> 3/4			<input checked="" type="checkbox"/> BP 1	<input checked="" type="checkbox"/>
Stiffeners 1,2,4,5	<input checked="" type="checkbox"/>			<input checked="" type="checkbox"/>	<input checked="" type="checkbox"/>
Stiffeners 3,6,7,8	<input checked="" type="checkbox"/>			<input checked="" type="checkbox"/>	<input checked="" type="checkbox"/>
Key profile	<input checked="" type="checkbox"/>			<input checked="" type="checkbox"/>	<input checked="" type="checkbox"/>
Leveling plate	<input checked="" type="checkbox"/>			<input checked="" type="checkbox"/> lp 1	<input checked="" type="checkbox"/>
				<input checked="" type="checkbox"/> LP 1	<input checked="" type="checkbox"/>
Fitting Plate 1	<input checked="" type="checkbox"/>			<input checked="" type="checkbox"/>	<input checked="" type="checkbox"/>
Number of fitting pl. 1 (DEF=1)				<input checked="" type="checkbox"/>	
Fitting Plate 2	<input checked="" type="checkbox"/>			<input checked="" type="checkbox"/>	<input checked="" type="checkbox"/>
Number of fitting pl. 2 (DEF=1)				<input checked="" type="checkbox"/>	
Fitting Plate 3	<input checked="" type="checkbox"/>			<input checked="" type="checkbox"/>	<input checked="" type="checkbox"/>
Number of fitting pl. 3 (DEF=1)				<input checked="" type="checkbox"/>	
Leveling plate hole diameter				<input checked="" type="checkbox"/>	
Key profile welded to				<input checked="" type="checkbox"/> Default	

Tolerance

Note:

- The anchor rod profile must be round to transfer to RISACONNECTION.

Column Welds

The base plate column flange and web weld size and type map to Tekla Structures weld options 1 and 2 respectively:

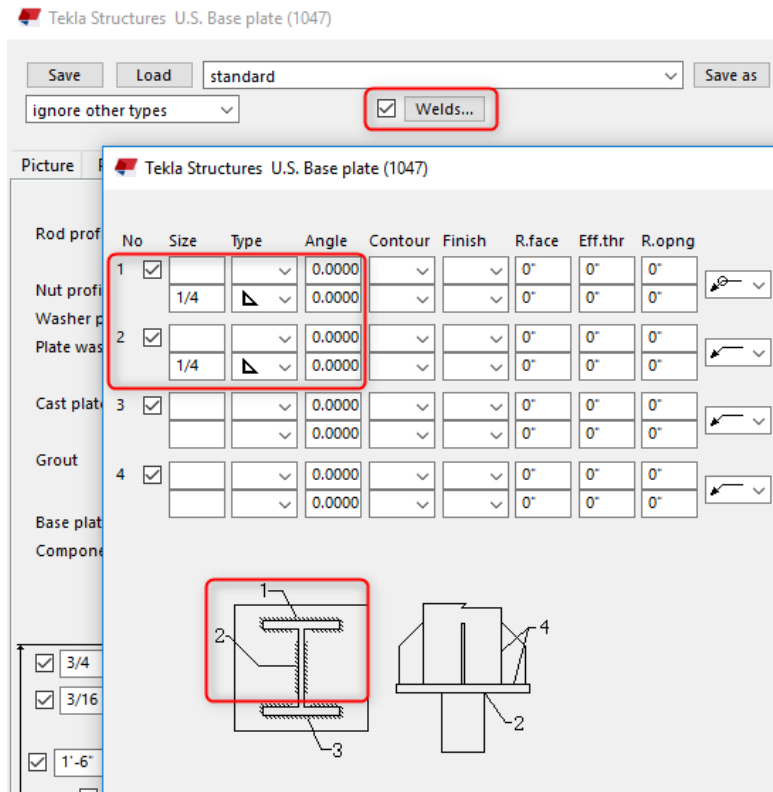

Note:

- Only double fillet, PJP, or CJP weld types are supported in RISACONNECTION.
- The flange welds must be the same size in RISACONNECTION, so only option 1 is used when mapping the flange weld properties.
- The flange weld is optional in RISACONNECTION, if weld option one is blank the connection will transfer without a flange weld.

Plate Washers (optional)

Plate washers can be added between the anchor bolts and column base plate. The plate washer size and material options are defined below:

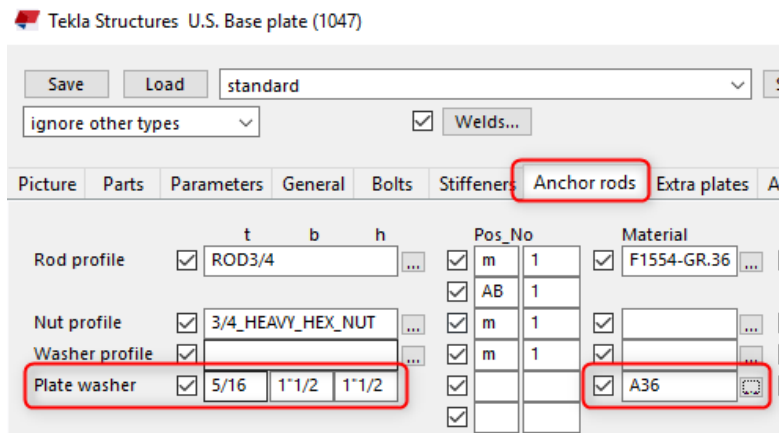

The plate washer weld in RISACONNECTION is defined between the washer and the base plate. However Tekla Structures does not have an option for this. Instead, the weld between the plate washer and anchor attribute is used by the link. To set the plate washer weld:

1. Select objects in components and then select the plate washer weld to define the properties of the weld:

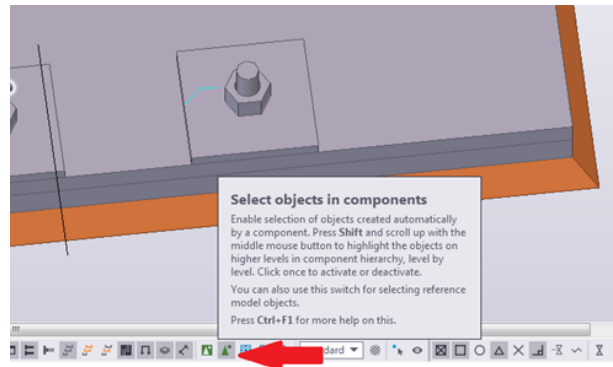

Note:

- RISAConnection's plate washer must be square, so use the smallest width or height dimension input in Tekla Structures if they are not equal.

Loading

Tekla Structure's Base Plate connection component 1047 does not contain loading considerations. RISAConnection will use the Column End Forces to map the loads.

Note:

- Axial Force: Positive magnitude denotes compression, negative magnitude denotes tension.
- Shear, V_y (major): Shear load along the weak axis of the column which causes strong axis bending.
- Shear, V_z (minor): Shear load along the strong axis of the column which causes weak axis bending.
- Moment, M_z (major): Moment about the strong axis of the column (only applicable to "Fixed" base plates).
- Moment, M_y (minor): Moment about the weak axis of the column (only applicable to "Fixed" base plates).

Warning and Error Log - RISACconnection

Below is a list of the warnings and errors in the link and further explanation for items which require it.

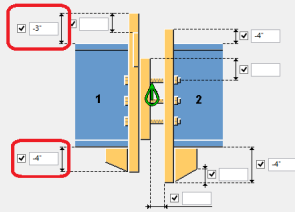
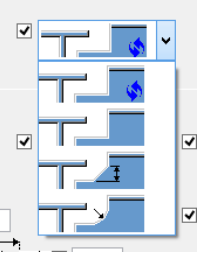

Warning Messages in the RISA-Tekla Link

Code	Message	Explanation
W0104	Connection member must be orthogonal (within 15 degrees) for RISACconnection	RISACconnection designs only orthogonal connections. If a beam comes into a column/girder at a slope, skew, or rotation less than 15 degrees from orthogonal the connection will still be designed. However, it will be designed as perfectly orthogonal.
W0105	Connection member must be parallel (within 15 degrees) for RISACconnection	For splice connections (columns or beams) RISACconnection can only design parallel connections. The RISA-Tekla link will bring over any splice connections that are within 15 degrees of parallel into RISACconnection, but they will be designed assuming they are perfectly parallel.
W0700	Missing value Electrode Classification for (name of weld) (default value of E70 used)	If there is a missing Electrode Classification then the program will warn you and then default to an E70 weld.
W0701	(name) value is missing or corrected (default value of (variable) used)	If there is a missing value that RISACconnection requires then the program will warn you and then default to the given value.
W0702	Missing doubler weld parameters for connection "Connection (number)"	If there are no welds defined for the doubler plate to the column in connection 134 then this message is produced.
W0703	Missing stiffener weld parameters for connection "Connection (number)"	If there are no welds defined for the stiffener to the column in connection 134 then this message is produced.
W0704	(name) value is missing or corrected (default value of (variable) used)	Similar to W0701, if there is a missing value that RISACconnection requires then the program will warn you and then default to the given value.
W0705	(name of load) was defined both in the Component and in the End Reactions. The program will use the Component value for "Connection (number)"	If you input loading in both the Component and End Reactions the Component value will be used.
W0707	Both Tension and Compression End Reactions were defined. The larger of the two values was used for "Connection (number)"	Because RISACconnection has only one input parameter the largest value is used.
W0708	(name of load) defined in the End Reactions on both members in splice "Connection (number)". The forces from member XX are being used.	Because RISACconnection has only one input parameter the loading from the "1" member in the Component is used.
W0709	(name of load) was defined in the Component in both the UDL% and Shear, V. The pro-	If you input loading in both the shear and UDL fields the program will use the direct shear value.

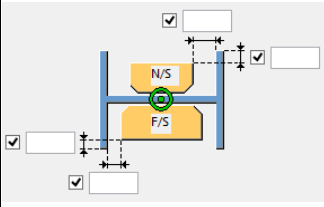
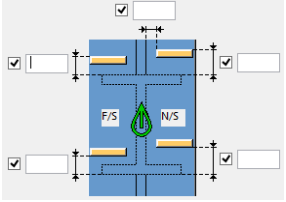
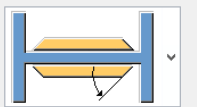
Code	Message	Explanation
	gram will use the Component Shear, V for "Connection (number)"	
W0710	(name of load) was defined in the End Reactions in both the UDL code and Shear, Vy. The program will use the End Reactions Shear, Vy for "Connection (number)"	If you input loading in both the shear and UDL fields the program will use the direct shear value.
W0713	The value of UDL is only applicable to Wide Flanges and Channels for calculation Shear Force in "Connection (number)"	The UDL tables from the AISC manual only contain Wide Flanges and Channels, thus those are the only shape types supported for this field.
W0801	Distance of end plate extending beyond beam/column flange must be equal on both flanges. This value has been updated to the smaller value.	 <p>This message will occur for Joining Plates (17) component.</p>
W1001	Circular notch must be used for RISACONNECTION. Other notch types not supported.	<p>The only cope/notch supported by RISACONNECTION is a circular one. If you use no chamfer or a line chamfer then RISACONNECTION will use a minimum value of 0.1". Note that the Tekla Structures model is not overwritten.</p> 
W1002	Welds that are not supported by RISACONNECTION have been ignored.	If there are weld types, sizes and electrode classifications defined for welds that are not actually used then this message is produced.
W1003	Bolt edge distance not supported for "Below" option. Default edge distance used for RISACONNECTION	In connection 146 on the Bolts tab in Tekla Structures there is an option to define where the bolt offset is defined from: Top, Middle, or Below. If "Below" is used RISACONNECTION does not recognize this and the default edge distance is used instead.
W1004	RISACONNECTION does not support different sizes or materials for moment plates. Both moment plates must be the same for "Connection (number)"	This message is telling you that your flange moment plates are different size or material. If this occurs the program will use the top plate parameters, updating the Tekla Structures model as well.
W1005	RISACONNECTION does not support different stiffener sizes or materials. All four stiffeners must be the same for connection "Connection (number)"	This message will appear if the Top NS, Top FS, Bottom NS, and Bottom FS stiffeners are not the same. If this is the case the program uses the Bottom NS size and material and uses it for all stiffeners, updating the Tekla Structures model as well.

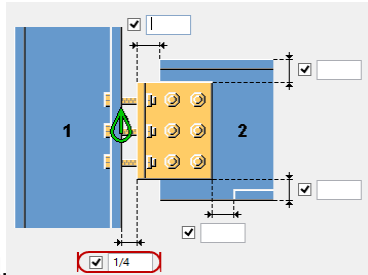

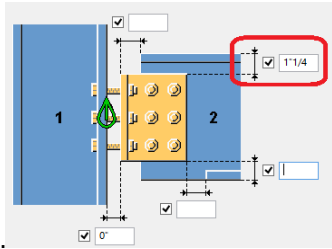
Code	Message	Explanation																																			
		<table border="1" style="width: 100%; border-collapse: collapse;"> <thead> <tr> <th></th> <th>t</th> <th>b</th> <th>h</th> <th>Pos_No</th> <th>Material</th> <th>Name</th> </tr> </thead> <tbody> <tr> <td>Top NS</td> <td><input checked="" type="checkbox"/> 1"</td> <td>3'11/3"</td> <td>1'-3'5/8"</td> <td><input checked="" type="checkbox"/></td> <td>A36</td> <td><input checked="" type="checkbox"/></td> </tr> <tr> <td>Top FS</td> <td><input checked="" type="checkbox"/> 1"</td> <td>3'11/3"</td> <td>1'-3'5/8"</td> <td><input checked="" type="checkbox"/></td> <td>A36</td> <td><input checked="" type="checkbox"/></td> </tr> <tr> <td>Bottom NS</td> <td><input checked="" type="checkbox"/> 1"</td> <td>3'11/3"</td> <td>1'-3'5/8"</td> <td><input checked="" type="checkbox"/></td> <td>A36</td> <td><input checked="" type="checkbox"/></td> </tr> <tr> <td>Bottom FS</td> <td><input checked="" type="checkbox"/> 1"</td> <td>3'11/3"</td> <td>1'-3'5/8"</td> <td><input checked="" type="checkbox"/></td> <td>A36</td> <td><input checked="" type="checkbox"/></td> </tr> </tbody> </table>		t	b	h	Pos_No	Material	Name	Top NS	<input checked="" type="checkbox"/> 1"	3'11/3"	1'-3'5/8"	<input checked="" type="checkbox"/>	A36	<input checked="" type="checkbox"/>	Top FS	<input checked="" type="checkbox"/> 1"	3'11/3"	1'-3'5/8"	<input checked="" type="checkbox"/>	A36	<input checked="" type="checkbox"/>	Bottom NS	<input checked="" type="checkbox"/> 1"	3'11/3"	1'-3'5/8"	<input checked="" type="checkbox"/>	A36	<input checked="" type="checkbox"/>	Bottom FS	<input checked="" type="checkbox"/> 1"	3'11/3"	1'-3'5/8"	<input checked="" type="checkbox"/>	A36	<input checked="" type="checkbox"/>
	t	b	h	Pos_No	Material	Name																															
Top NS	<input checked="" type="checkbox"/> 1"	3'11/3"	1'-3'5/8"	<input checked="" type="checkbox"/>	A36	<input checked="" type="checkbox"/>																															
Top FS	<input checked="" type="checkbox"/> 1"	3'11/3"	1'-3'5/8"	<input checked="" type="checkbox"/>	A36	<input checked="" type="checkbox"/>																															
Bottom NS	<input checked="" type="checkbox"/> 1"	3'11/3"	1'-3'5/8"	<input checked="" type="checkbox"/>	A36	<input checked="" type="checkbox"/>																															
Bottom FS	<input checked="" type="checkbox"/> 1"	3'11/3"	1'-3'5/8"	<input checked="" type="checkbox"/>	A36	<input checked="" type="checkbox"/>																															
W1006	<p>RISAConnection does not support the stiffener size reduction from connection "Connection (number)". Full height stiffener used.</p>	<p>This message will be given if a partial width column stiffener is used. It will also be given if a partial depth stiffener is used if the stiffener is attached to neither flange. RISAConnection assumes a full height/depth stiffener for design and updates the Tekla Structures model with these dimensions.</p> 																																			
W1007	<p>RISAConnection is ignoring the displacement of stiffeners from connection "Connection (number)"</p>	<p>This message will be given if column stiffeners are offset vertically from the beam flange or horizontally from the column web locations. RISAConnection assumes the stiffeners are located at the flange locations. Note that these values are not overwritten in Tekla Structures.</p> 																																			
W1008	<p>RISAConnection is ignoring the bevel in doubler plates from Flange Moment Plate (134)</p>	<p>RISAConnection uses fully rectangular doubler plates, but will not overwrite the Tekla Structures model.</p> 																																			
W1009	<p>RISAConnection is ignoring holes in doubler plates from connection "Connection (number)"</p>	<p>RISAConnection assumes the doubler are solid, without the presence of holes, but will not remove the holes in Tekla Structures.</p>																																			
W1010	<p>RISAConnection is using the transverse stiffener width based on column shape in connection "Connection (number)"</p>	<p>RISAConnection requires the transverse stiffener width must match the column width. This dimension will be updated in Tekla Structures.</p>																																			
W1011	<p>RISAConnection is using the transverse stiffener depth based on column shape in connection "Connection (number)"</p>	<p>If a transverse stiffener is used where the depth dimension is larger than what will fit the column this message will be given and Tekla Structures will be updated with the full depth length.</p>																																			
W1012	<p>RISAConnection is using the doubler plate width based on column shape in Flange Moment Plate (134)</p>	<p>RISAConnection requires the doubler plate width to be equal to $(d_{col} - 2*t_f)$, However, this will not be overwritten in Tekla Structures.</p>																																			
W1013	<p>RISAConnection is using the doubler plate depth based on column shape in Flange Moment Plate (134)</p>	<p>The depth of the doubler plate used in RISAConnection comes from the AISC Design Guide #13 Figure 4-3 and is defined as $d_{beam} + 2*t_{flangeplate} + 2*(2.5*k_{descol})$. This is the size that will be used in RISAConnection, but Tekla Structures will not be updated.</p>																																			

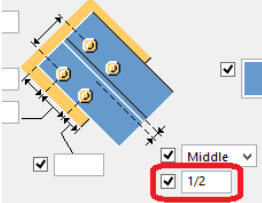
Code	Message	Explanation
W1014	All stiffener plate welds must be the same in connection "Connection (number)"	RISAConnection requires stiffener plate welds to be the same on all sides. If they are not they will be updated in Tekla Structures to be the same value.
W1015	All doubler plate welds must be the same in connection "Connection (number)"	RISAConnection requires doubler plate welds to be the same at the top and bottom of the plates. They also must be the same on the left and right. If they are not they will be updated in Tekla Structures to the value in RISAConnection.
W1016	RISAConnection supports only single fillet welds on doubler plates in connection "Connection (number)"	If all welds are defined as something other than a fillet weld then this message will occur. RISAConnection will use fillet welds and update the Tekla Structures model.
W1017	All moment welds must be the same in "Connection (number)"	The top and bottom welds must be identical for moment connections. If they are different RISAConnection will update the welds to match and update the Tekla Structures model as well.
W1018	RISAConnection is ignoring Weld Access Holes from "Connection (number)"	Weld access holes in RISAConnection can not be edited. The dimensions are set specifically per the AISC. Because of this this information is not mapped with the RISA-Tekla Link.
W1019	RISAConnection is locating column stiffeners nearest to the connection, rather than centering them	For certain components in Tekla Structures it is difficult to get a partial depth stiffener located properly. In this case RISAConnection will place the stiffener next to the column flange nearest the connection without altering the location in Tekla Structures.
W1020	RISAConnection is ignoring the lifting hole from "Connection (number)"	If a lifting hole is defined in the component it is ignored in RISAConnection for design purposes.
W1021	The gap between column/girder and connector is not supported in RISAConnection	RISAConnection does not support a gap between a column/girder and the connector element. The Tekla Structures  model will also be updated.
W1022	RISAConnection is ignoring deck plates from "Connection (number)"	When deck plates are used in a component in Tekla Structures they are ignored in RISAConnection.
W1023	Both flange welds (top and bottom) on the same beam/-column must be equal in "Connection (number)"	RISAConnection requires both sides of a weld to be the same size. If different welds are placed RISAConnection will use the first value and this will be updated in Tekla Structures.
W1024	RISAConnection is ignoring the gap between end plates from "Connection (number)"	If there is a gap between end plates in a splice connection this gap is ignored in RISAConnection for design purposes.
W1025	RISAConnection is ignoring ear plates from "Connection (number)"	RISAConnection doesn't support ear plates so they are ignored. However, they remain in Tekla Structures.
W1026	RISAConnection is ignoring	RISAConnection doesn't support any holes that are not spe-

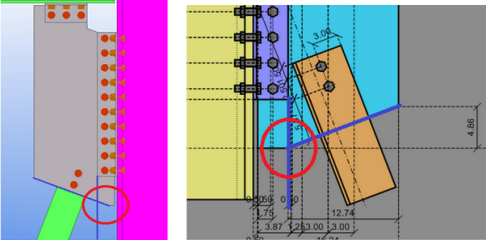
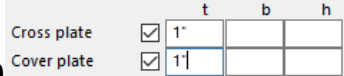
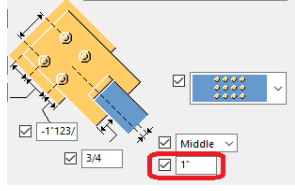
Code	Message	Explanation
	holes in end plates from "Connection (number)"	cifically for bolts. Any holes for lifting or other purposes are ignored, but will be left in the Tekla Structures model.
W1027	RISAConnection is ignoring the interior flange plates from "Connection (number)"	For splice connections RISAConnection only supports flange plates on the outside of the section. Any interior flange plates will be ignored in RISAConnection but remain in Tekla Structures.
W1028	RISAConnection is ignoring flange/web spacers from "Connection (number)"	For connections where flange or web spacers are defined, these are ignored in RISAConnection but remain in Tekla Structures.
W1029	There is a moment force defined on a shear connection. These forces are ignored for connection design for "Connection <TS conn #>	In Tekla Structures you can add moment forces to nearly all of the connection Components. Many of these are traditionally shear connections. In RISAConnection many of these connections don't have moment force inputs, thus the link is letting you know that these moment forces will not be considered.
W1030	RISAConnection is setting the position of the shear plate on the center from "Connection (number)"	In RISAConnection the shear plate for column splice connections is always centered on the connection. If this value is not centered in Tekla Structures RISAConnection will update this value in RISAConnection and Tekla Structures.
W1031	The connector has been moved vertically to the supporting beams K-distance	RISAConnection requires a connection to be at least a distance "k" from the top of the flange in a clip angle, shear tab, or end plate connection. This dimension will be updated in Tekla Structures as well. 
W1032	RISAConnection is ignoring clip angle for attaching brace from "Connection (number)"	For a vertical brace connection in Tekla Structures it is possible to add an extra clip angle to connect the brace to the gusset. This is not supported in RISAConnection and will be ignored. 
W1033	RISAConnection is shifting brace bolt group symmetrically about the axis of the brace from "Connection (number)"	For WT vertical brace connections in RISAConnection the bolt pattern that attaches the brace to the gusset must be symmetric. If there is an offset here it will be updated to 0 with a round-trip of the RISA-Tekla Link. 
W1034	RISAConnection is ignoring seal plates for attaching brace from "Connection (number)"	Because seal plates are non-structural they are not considered in RISAConnection.
W1035	RISAConnection is changing the Workpoint Location for top and bottom sub-connections to	RISAConnection has three ways to model a top and bottom brace condition: <ul style="list-style-type: none"> Both braces concentric on beam column workpoint. If

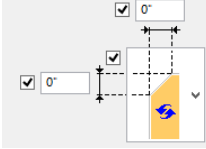

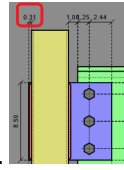
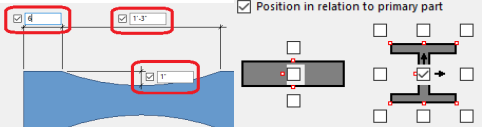
Code	Message	Explanation
	<p>CONCENTRIC in Vertical Brace diagonal Connection</p>	<p>both braces are within 2" of the workpoint they will be made concentric and will be transferred..</p> <ul style="list-style-type: none"> Both braces equally eccentric along the beam. If both braces are eccentric along the beam and within 2" of each other the program will use the larger value of eccentricity and the connection will be transferred. Both braces eccentric along the column. These do not have to be identical and will be transferred. <p>If bullet item 1 requires RISACONNECTION to make the connection concentric then this message will be given. Note that because angles are drawn along centerlines in Tekla Structures and along the shear center in RISACONNECTION you may see this message even if single angles are drawn to the column/beam workpoint in Tekla Structures.</p>
<p>W1036</p>	<p>Top and bottom brace workpoints have unequal eccentricities along beam from column/beam workpoint location in Vertical Brace Diagonal connection. RISACONNECTION requires an equal value and will use the larger of these two eccentricities</p>	<p>RISACONNECTION has three ways to model a top and bottom brace condition:</p> <ul style="list-style-type: none"> Both braces concentric on beam column workpoint. If both braces are within 2" of the workpoint they will be made concentric and will be transferred.. Both braces equally eccentric along the beam. If both braces are eccentric along the beam and within 2" of each other the program will use the larger value of eccentricity and the connection will be transferred. Both braces eccentric along the column. These do not have to be identical and will be transferred. <p>If bullet item 2 requires RISACONNECTION to use the larger value of eccentricity then this message will be given.</p>
<p>W1037</p>	<p>Gusset clip dimensions have been edited in RISACONNECTION. RISACONNECTION limits the clip so that it does not pass the projected edge of the gusset/beam or gusset/column clip angle in "Connection (number)"</p>	<p>In Tekla Structures it is possible to layout a clip on the gusset that isn't supported in RISACONNECTION. The clip can not extend past the projection of the beam/gusset or column/gusset clip angle. If this occurs in Tekla Structures RISACONNECTION will then update this clip.</p> 
<p>W1038</p>	<p>RISACONNECTION is ignoring cross plates from connection "Connection (number)"</p>	<p>RISACONNECTION doesn't support these extra plates on Component Tube gusset (20)</p> 
<p>W1039</p>	<p>RISACONNECTION does not support an eccentric bolt group on the knife plate from "Connection (number)". This will update in Tekla Structures.</p>	<p>The bolt group must be centered on the brace in the knife plate connection.</p> 

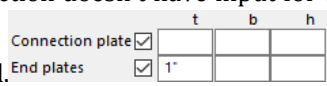
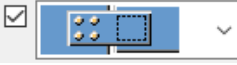

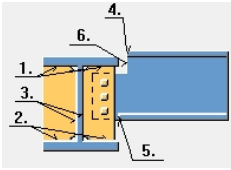

Code	Message	Explanation
W1040	Corner clips on the brace knife plate for "Connection (number)" will be ignored as these clips are not supported in RISAConnection	RISAConnection does not support clips on the knife plate in a brace connection. If you choose this option in Tekla Structures it will be ignored in RISAConnection and updated on a roundtrip back to Tekla Structures. 
W1041	RISAConnection is ignoring chamfers in shear plate from connection "Connection (number)"	RISAConnection does not support chamfers on shear tab connections, however, it will not overwrite these in Tekla Structures. 
W1042	The length of end plate above and below the beam flanges must be equal for "Connection (number)" in RISAConnection and will be updated.	If the length above and below are different then RISAConnection will take the average length and put half above and half below and update the Tekla Structures model.
W1043	The end plate stiffener geometry above and below the beam flanges must be equal for "Connection (number)" in RISAConnection and will be updated.	If two different thicknesses are defined for end plate stiffeners above and below a beam the program will use the smaller thickness for both stiffeners in RISAConnection and update the Tekla Structures model as well.
W1044	The end plate and stiffener plate material for "Connection (number)" must be the same in RISAConnection and will be updated.	RISAConnection will always use the end plate material for the stiffeners and this will be updated in Tekla Structures.
W1045	The end plate bolt configuration must be symmetric about the centroid of the beam for "Connection (number)" in RISAConnection and will be updated.	RISAConnection will make the connection symmetric by updating the vertical bolt spacings and this will be updated in Tekla Structures.
W1046	This end plate configuration does not support end plate stiffeners for "Connection (number)" in RISAConnection. The stiffeners will be removed.	RISAConnection has explicit requirements for end plate stiffeners on certain end plate bolt configurations. This connection requires no stiffeners present and they will be removed in Tekla Structures.
W1047	This end plate configuration requires end plate stiffeners for "Connection (number)" in RISAConnection. Stiffeners will be added.	RISAConnection has explicit requirements for end plate stiffeners on certain end plate bolt configurations. This connection requires them and they will be added in Tekla Structures.
W1048	RISAConnection will update end plate stiffener geometry per AISC Design Guide #4, 2nd edition, recommendations for "Connection (number)".	RISAConnection uses only the geometry for stiffeners given directly from the AISC Design Guide #4 2nd edition, page 16, which, given h_{st} , explicitly defines the stiffener geometry. Hence, a 30 degree clip in the stiffener with 1" landings is always used. The stiffeners will be updated when going back to Tekla Structures.

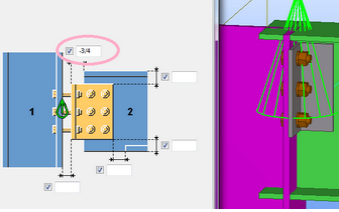

Code	Message	Explanation
W1049	RISACONNECTION is correcting form or size of Shear Plate from "Connection (number)".	This warning will occur in the Shear plate tube column (189) Component and is in regards to the extension distance of the through plate past the column. In Tekla this dimension can be freely edited. However, in RISACONNECTION this dimension is uneditable and set to the minimum shelf dimension for welds from Section J2 of the AISC 360 spec. This dimension is therefore not mapped. 
W1050	RISACONNECTION is moving the center line of beam relative to center line of column for "Connection (number)"	RISACONNECTION will only support connections centered on a column center line. If a Tekla Structures connection does not line up it will be brought into RISACONNECTION centered. However, Tekla Structures will remain unchanged in this regard.
W1051	RISACONNECTION is ignoring the requested DogBone configuration for "Connection (number)"	For odd dogbone configurations applied to the Column with stiffeners W (182) component where dimensions are 0 or negative, or the position is offset, the dogbone will be ignored in RISACONNECTION. 
W1052	RISACONNECTION supports only symmetrical location of Bolt Group about the central axis of Brace Plate in "Connection (number)"	The connection between the brace web and the gusset must have a bolt group that is centered on the brace plate. RISACONNECTION will update this configuration and Tekla Structures will be updated
W1053	RISACONNECTION is ignoring the Filler Plate for "Connection (number)"	If a filler plate is defined on the brace connection it will be ignored.
W1054	RISACONNECTION is ignoring the Upper and Lower Shear Tab for "Connection (number)"	If an upper or lower shear tab is defined on the brace connection it will be ignored.
W1055	RISACONNECTION is ignoring the gap between clip angles for brace in "Connection (number)"	If a gap is defined between the clip angles attached to the brace flange and the gusset this will be ignored. 
W1056	RISACONNECTION is ignoring end-plates on braces in "Connection (number)"	RISACONNECTION doesn't have input for these plates so they are ignored. 
W1057	RISACONNECTION is ignoring the plate used for attaching the brace in "Connection (number)"	Tekla allows the use of an extra plate for attaching the brace to the gusset, which is unsupported in RISACONNECTION. The Tekla setting will be ignored. 
W1059	RISACONNECTION is ignoring the Plate to gus. pl for "Connection (number)"	This extra plate is not supported on Connection 62.

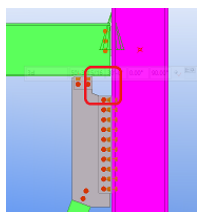
Code	Message	Explanation
	(number)"	<div style="border: 1px solid black; padding: 5px;"> Plate1 to gus.pl <input checked="" type="checkbox"/> 1" <input type="text"/> <input type="text"/> Plate2 to gus.pl <input type="checkbox"/> <input type="text"/> <input checked="" type="checkbox"/> 1" </div>
W1060	All shear plate welds must be the same in "Connection (number)"	In Tekla there are weld inputs for top flange, web and bottom flange. In RISAConnection there is only one input. Thus, the program uses the "1" weld in all locations and will update the <div style="text-align: center;">  <p>Tekla model.</p> </div>
W1061	RISAConnection is correcting the Brace/Gusset Gap and Web Plate WorkPoint Distance in "Connection (number)"	This warning will occur if the end of brace and the clip on the gusset plate aren't parallel.
W1062	RISAConnection does not support different values of Top and Bottom Vertical Edge Distance of Bolts to Edge of Shear plate. The Top edge distance is used for connection <TS conn#>	The vertical edge distance from the shear plate to the top bolts and the shear plate to the bottom plate must be equal.
W1063	RISAConnection does not support different values of Top and Bottom Vertical Edge Distance of Bolts to Edge of Shear plate. If Top and Bottom edge distances are not equal the average value between the two is used for connection <TS conn#>	The vertical edge distance from the shear plate to the top bolts and the shear plate to the bottom plate must be equal.
W1064	RISAConnection is ignoring the doubler plate from connection <TS conn #>	Doubler plate is not supported for this connection in RISAConnection, however it will remain in the Tekla Structures model.
W1065	RISAConnection does not support Moment Beam Bolts configuration with the number of columns other than 2. The number of columns will be changed to 2 for connection <TS conn#>	RISAConnection allows Moment Beam Bolts configuration with a maximum of two columns of bolts.
W1066	RISAConnection is ignoring the gaps between Beam and Moment Plates and correcting the depth value of Shear Plate in connection <TS conn #>	Beam flange plates must be flush with the column. Shear plate depth may be modified to ensure bolt constructability.
W1067	All moment column welds must be the same in connection <TS conn #>	RISAConnection requires the column welds to use the same size.
W1068	All moment plate welds must be the same in connection <TS conn #>	RISAConnection requires the

Code	Message	Explanation
W1069	RISACONNECTION adds the web weld between the column and the beam in connection <TS conn #>	The column and beam must be connected by a weld at the web.
W1070	RISACONNECTION is changing the Depth of Shear Plate because the central axis of Flange Plates must be joined to the central axis of Beam's Flanges only in RISACONNECTION	Flange plates must be centered on the beam flange in RISACONNECTION.
W1071	The beam and flange plates overlap in the Tekla model, because of this RISACONNECTION will move the bolt group	The flange plates must be assigned on the outside of the beam flanges for RISACONNECTION to create the bolt group.
W1072	The base plate must be rectangular. RISACONNECTION is ignoring the tapered corners in the Base Plate in connection <TS conn #>	RISACONNECTION only supports a rectangular base plate shape.
W1073	RISACONNECTION is ignoring the key profile in connection <TS conn #>	Key profile is not used in RISACONNECTION, however this input will remain in Tekla Structures.
W1074	RISACONNECTION is ignoring the Leveling plate in connection <TS conn #>	Connection is transferred to RISACONNECTION Base Plate without leveling plates.
W1075	RISACONNECTION supports only equal flange welds between the column and the base plate in connection <TS conn #>	The weld size and length must be the same on each side of the column flange.
W1076	RISACONNECTION only uses one anchor rod bolt size and material. All of the parameters in the anchor rod assembly that differ from those used in RISACONNECTION will be ignored	The anchor rod profile with the smallest diameter will be transferred to all anchor bolts in RISACONNECTION's base plate.
W1077	The length and width in plate washers must be equal for connection <TS conn #> in RISACONNECTION and will be updated to (variable)	Plate washers in RISACONNECTION's base plate must be square.
W1078	RISACONNECTION does not support different plate washer welds sizes in connection <TS conn #>. Connection is transferred using Tekla's smallest weld size assigned to the weld between the plate washer and anchor	All plate washer weld sizes in RISA's base plate connection must be the same size. Connection is transferred using Tekla's smallest weld size assigned to the weld between the plate washer and anchor.
W1079	RISACONNECTION supports only	RISACONNECTION's base plate connection must have equal size

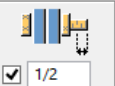
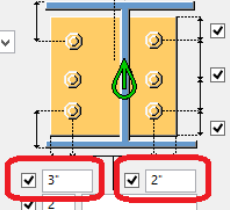
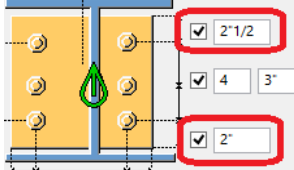
Code	Message	Explanation
	equal column welds between the column and the base plate in connection <TS conn #>	welds around the column.
W1080	Loads from <TS conn #> are transferred to RISAConnection using the column End Condition forces	Connection 1047 in Tekla does not contain connection attributes to link with RISAConnection loading. RISAConnection will use the column end condition forces.
W1100	The cut length for the beam must be ≥ 0 "	If the distance from the edge of the clip angle to the end of the beam is < 0 then this dimension will be ignored and updated to zero in Tekla Structures. 
W1101	Unsupported weld type. The weld type has been changed in RISAConnection to "Weld Type".	RISAConnection only supports certain weld types in certain conditions. If RISAConnection does not support this weld type it will be updated to the item specified in RISAConnection. Tekla Structures will keep its weld type, though the size of the weld will update accordingly.
W1102	Beam end must be prepared in "Connection (number)"	For directly welded moment connections there can be a variety of weld access hole dimensions. RISAConnection doesn't support these, so this message is given.
W1103	The gap between Column (Girder) and Beam is changed to zero in RISAConnection	This warning will be given if a negative distance is read in for this gap. Any positive value will be taken to RISAConnection properly. The negative value will be updated to 0 in Tekla Structures
W1104	The distance between the beam and the flange plates is changed to zero.	If there is a gap between the flange plate and the moment beam the program will ignore this and assume there is no gap. This gap will remain in Tekla Structures.
W1105	RISAConnection is ignoring the Stiffener from "Connection (number)"	For many connections RISAConnection does not perform stiffener checks. In these cases the connection is designed but the stiffener is not considered. For connection 134 stiffener checks are performed. However, they are ignored if the stiffeners are partial depth and are attached to the opposite column flange from the connection. In this case the stiffener does not support the column flange with the connection so it is ignored. For connection 62 stiffeners are not supported.
W1106	RISAConnection is ignoring fill information from "Connection (number)"	Some connections (134 for example) in Tekla Structures have a fill material implicit in the connection. RISAConnection does not consider this fill, but it will remain in Tekla Structures.
W1107	RISAConnection is changing to zero the gap between Column (Beam) and Clip Angles for "Connection (number)"	RISAConnection does not support a non-zero value for Erection Clearance. A gap distance of zero will be used, though the value will be left in Tekla Structures. 
W1108	RISAConnection is ignoring the	RISAConnection does not consider haunch plates in the con-

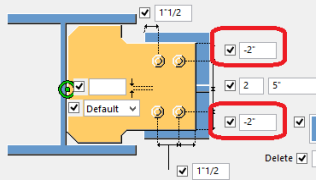
Code	Message	Explanation
	Haunch plates from "Connection (number)"	nection design for any connections, however, they will remain in Tekla Structures.
W1109	Interior notch of gusset not supported in RISACONNECTION. Notch will be removed from "Connection (number)"	If there is a cut-out on the interior of the gusset that will not be considered in RISACONNECTION and will be removed with a round-trip of the link. 
W1110	RISACONNECTION is ignoring the Notch from Connection "Connection (number)"	RISACONNECTION does not support this type of notching. It will bring the connection as a traditionally coped member. 
W1111	RISACONNECTION is ignoring the Manual Notch from "Connection (number)"	RISACONNECTION will not consider any notches added as a "Manual Notch", however these notches will remain in Tekla Structures. 
W1112	Shape of gusset not supported by RISACONNECTION, so gusset plate clip dimensions are the RISACONNECTION default for "Connection (number)"	RISACONNECTION does not support the gusset shape shown here 
W1117	RISACONNECTION is ignoring the extra length of the bolts	If there is a gap between the flange plate and the beam flange, extended bolts are required. RISACONNECTION, however, does not consider the length of these bolts. This can also occur if a non-zero value is entered in a component in this location. 
W1119	RISACONNECTION used the minimum bolt horizontal edge distance	RISACONNECTION must have symmetric horizontal edge distances. The program will use the smaller of the two values and will update Tekla Structures. 
W1120	RISACONNECTION used the minimum bolt vertical edge distance	RISACONNECTION must have symmetric vertical edge distances. The program will use the smaller of the two values and will update Tekla Structures. 
W1122	RISACONNECTION used the minimum moment bolt horizontal	If the moment bolt edge distance is less than zero then RISACONNECTION will update this value to 0" in Tekla Struc-

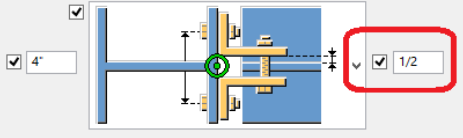
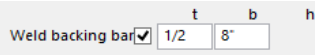
Code	Message	Explanation
	edge distance	 <p>ures.</p>
W1126	RISAConnection is ignoring the Seat Angle and Seat Plate from connection "Connection (number)"	<p>If a Tekla Structures connection has a seated connection this will be ignored in RISAConnection and will remain in Tekla Structures.</p> 
W1127	RISAConnection is ignoring the Fitting Plate from connection "Connection (number)"	<p>RISAConnection doesn't support these fitting plates so they are ignored, however they remain in Tekla Structures.</p>
W1128	RISAConnection is ignoring the Folded Plate from connection "Connection (number)"	<p>If there is a folded plate defined in connection 144 this plate is ignored in RISAConnection. It will remain in the Tekla Structures model.</p>
W1131	RISAConnection is ignoring the bottom notch of the Beam from connection "Connection (number)"	<p>RISAConnection ignores this notch, however it will remain in Tekla Structures.</p> 
W1136	RISAConnection is ignoring the weld gap from connection "Connection (number)"	<p>In Tekla Structures it is possible to define two members as welded together though there is a gap between the elements. RISAConnection will ignore the gap in this case.</p> 
W1137	RISAConnection is ignoring the weld backing bar from connection "Connection (number)"	<p>RISAConnection does not consider a backing bar (from Beam Cut tab in component) in design, however it will remain in Tekla Structures.</p> 
W2001	TeklaStructures supports only equal welds on doubler plates in connection "Connection (number)"	<p>RISAConnection allows for different electrode types for doubler plates for top/bottom and left/right welds. The Tekla components do not have an option for this, however, the welds themselves will be updated properly if the welds are different in RISAConnection. If you modify the connection again using the component then this will be overwritten.</p>
W2002	Tekla Structures does not support this gusset clip geometry and will update it for "Connection (number)"	<p>For vertical brace connections using Components 59 or 60, those Components have less geometric flexibility than RISAConnection allows relating to the gusset clip. If the connection is modified in RISAConnection to odd configurations where the brace framing does not land on the gusset clip then Tekla Structures may adjust the connection to make the clip and angle line up.</p>
W2003	Flange coping of channel members framing to a column web is not supported for Shear Plate Connection (146). Both	<p>Because the default centerlines of members are different between Tekla Structures and RISAConnection, flange coping (especially for channels) may be different for the two programs. Because this type of cope is rare it is being ignored.</p>



Code	Message	Explanation
	programs will act independently for this parameter.	
W2004	The Near and Far welds in "Connection (number)" from the shear plate to the tube are a different size, which is not supported in Tekla Structures. The Near weld size will be used in both locations	RISACONNECTION requires both welds to be the same, so we use the near weld for both sides.
W2005	Tekla Structures does not support DogBone in this Template. The DogBone and Seismic Loads will be ignored for "Connection (number)" in Tekla Model	Some Tekla environments do not have the DogBone component. Thus, if a Dogbone is created on Component Column with stiffeners W in RISACONNECTION, the DogBone will be ignored in Tekla.
W2006	Tekla Structures does not support a double Web Plate on one brace and a single Web Plate on the other for "Connection (number)"	In Tekla Structures, for a chevron connection with Wide Flange braces, a single or double web plate must be defined the same for both braces. In RISACONNECTION you can define them differently. RISACONNECTION will leave the settings as given in Tekla.
W2007	Tekla Structures does not support not equal value of Brace/Gusset Gap on left and right braces for "Connection (number)". The value of (variable) is used in Tekla Model.	For chevron connections in RISACONNECTION the gap between the brace and the gusset can be different for the two chevrons. In Tekla this is a single input.
W2008	Tekla Structures does not support Moment Plates with tapered shape for connection <TS conn #>. The Full Width shape for Moment Plates is used in Tekla Model.	Moment plates must be rectangular in RISACONNECTION.
W2009	Tekla Structures does not support Web Weld. The Web Weld will be ignored for connection <TS conn #> in Tekla Model	The web weld will not be transferred to RISACONNECTION.
W2010	Tekla Structures supports only equal Moment Column Welds and Stiffeners Welds. The Stiffeners Weld will be equated to Moment Column Welds for connection <TS conn #> in Tekla Model	RISACONNECTION uses equal weld sizes for stiffeners and column welds.
W2011	Tekla Structures works incorrectly with values of Beam Bolts Vert Edge Dist Bottom less than 0.5 inch thus these values were changed to be equal 0.5 inch for connection <TS conn #> in Tekla Model	The vertical edge distance from the bottom beam bolts to the shear plate edge must be greater than or equal to 0.5 inches.

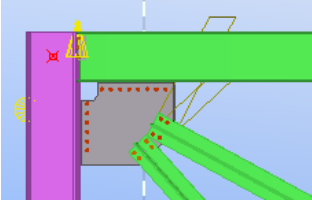

Code	Message	Explanation
W3000	Unsupported hole type: RISACONNECTION is using the default hole type STD	RISACONNECTION only supports certain bolt hole configurations. See the Mapping Behavior topic for more information.
W3001	Unsupported electrode type: RISACONNECTION is using the default weld E70	RISACONNECTION supports E60, E70, E80, E90, E100 and E110. Any other weld electrodes will be defaulted to E70 and will update the Tekla Structures model.
W3002	Unsupported bolt type: RISACONNECTION is using the default bolt A307	RISACONNECTION supports A307 (N & X), A325 (N & X) and A490 (N & X) bolts. All other bolts will default to A307-N, but the material will not update in Tekla Structures.
W3003	Unsupported clip angle: RISACONNECTION is using the default clip angle L4X3X5/16	RISACONNECTION can only support connections in RISA shape databases. If this shape does not exist the program will use a default, however the shape will remain in Tekla Structures.
W3005	Unsupported Material: RISACONNECTION is using the default material A36	RISACONNECTION allows A36, A529, A572, A588, A852, A913 and A992 steel materials. All other materials will default to A36. If it is a component of the connection then the material will get updated to A36 in Tekla Structures. If it is a member in the model then the material will not get updated in Tekla Structures.
W3100	RISACONNECTION doesn't support profile <Profil Name>. For <Member Name> RISACONNECTION is using the default <Shape's tupe> <Default Profil Name> for <TS conn #>	RISACONNECTION can only support shapes in RISA shape databases. If this shape does not exist the program will use a default, however the shape will remain in Tekla Structures. The same behavior goes for parametric profiles.
W3501	Unsupported bolt diameter for (bolt location): RISACONNECTION is using the nearest supported diameter (bolt diameter)	RISACONNECTION only supports specific sizes of metric bolts (16, 18, 20, 22, 24, 27, 30, 36 mm). Any other size brought over from Tekla Structures will be updated to the nearest value in RISACONNECTION. This updated diameter will also be updated in Tekla Structures.

Error Messages in the RISA-Tekla Link

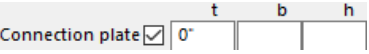
Code	Message	Explanation
E0001	Unsupported Connection Type	This will occur if you have assigned a connection to RISACONNECTION that is not supported.
E0002	Member shape type not supported for this connection	If you are using a shape or shape type in this connection that is not supported in RISACONNECTION you will get this message.
E0003	Profile XX for Member XX is absent in Profile Catalog	This is a rare error that could possibly occur if you draw a shape in one environment and then open that model in a different environment.
E0004	Vertical Brace Diagonal Connection (59 or 60) must also have a beam to column connection to be supported by RISACONNECTION. Please assign Clip angle (141) or Shear plate simple (146) to the beam/-column intersection.	For RISACONNECTION to support these vertical brace connections you must have both a vertical brace Component defined and a column/beam component defined. If you've only defined the brace connection Component then you will get this message.
E0100	RISACONNECTION only supports Vertical Brace Diagonal Connection (59) with a knife plate for tube or pipe braces	Tekla Structures component 59 is only supported with the RISA-Tekla Link (and in RISACONNECTION) if the brace is a tube or pipe. RISACONNECTION does not support a knife plate connection for any other brace shape types.



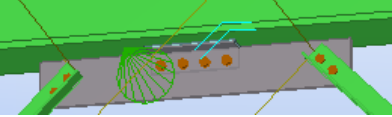
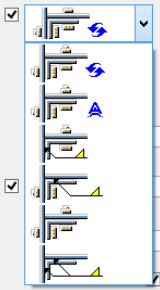

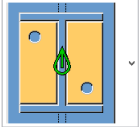

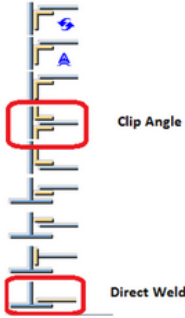
Code	Message	Explanation
E0101	RISACconnection only supports double angle vertical braces if the two angles are equal and of similar orientation	Both angles of a double angle brace must be equal and of the same orientation to transfer into RISACconnection.
E0103	RISACconnection only supports Vertical Brace Diagonal Connection with one brace	RISACconnection does not support having multiple braces coming into the same column/beam brace connection location. 
E0104	Connection member must be orthogonal (within 15 degrees) for RISACconnection	Girder/beam and column/beam connections are always brought into RISACconnection orthogonally. If the connection slope, skew or rotation is not within 15 degrees from orthogonal then the connection will not go to RISACconnection.
E0105	Connection member must be parallel in "Connection (number)"	For splice connections (columns or beams) RISACconnection can only design parallel connections. The RISA-Tekla link will not bring over any splice connections that are greater than 15 degrees from parallel.
E0106	RISACconnection only supports connections with beams, the upper plane of which is at the same level	The position in Tekla Structures must be such that for beams in a splice connection the top flanges must line up. If they do not then the link will not transfer the connection.
E0107	RISACconnection only supports connections with beams which are not shifted relative to one another.	The position in Tekla Structures must be such the vertical centerline of two splice members must line up. If they do not then the link will not transfer the connection.
E0108	RISACconnection only supports connection with NEGATIVE dist from end plate to upper edge of beam.	For end plate splice connections, only a specific bolt and plate configuration can work. The end plate must extend past the beam flanges and also have bolts beyond the flanges.
E0109	RISACconnection only supports connection with NEGATIVE dist from end plate to upper edge of column.	For end plate splice connections, only a specific bolt and plate configuration can work. The end plate must extend past the column flanges and also have bolts beyond the flanges.
E0110	RISACconnection only supports connection with equal dist from end plate to side edge of column	For end plate splice connections, the end plate must extend an equal distance past the flanges on both sides.
E0111	For Vertical Brace Diagonal connections in RISACconnection with both top and bottom braces, the workpoint locations for the braces must be within 2" to transfer. That or both workpoints must land on the column per RISACconnection requirements	RISACconnection has three ways to model a top and bottom brace condition: <ul style="list-style-type: none"> • Both braces concentric on beam column workpoint. If both braces are within 2" of the workpoint they will be made concentric and will be transferred.. • Both braces equally eccentric along the beam. If both braces are eccentric along the beam and within 2" of each other the program will use the larger value of eccentricity and the connection will be transferred. • Both braces eccentric along the column. These do not have to be identical and will be transferred. <p>If none of these requirements are met then this message will be given.</p>
E0112	RISACconnection only supports Connection (number) with the beam from one side	The column/beam shear through plate connection (Shear plate tube column (189) component) for tube/pipe columns is only

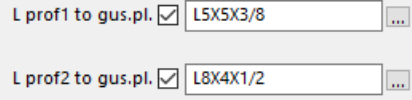
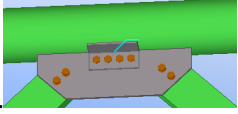
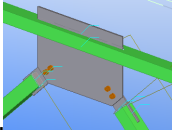

Code	Message	Explanation
	only	supported in RISAConnection for a beam on one side of the connection. If you have a connection on both sides you will get this error.
E0113	RISAConnection does not support this shape type for brace in Connection (number).	This Component requires the brace to be a specific shape. Please see the Before you Begin topic for an explanation of which Components support which brace types.
E0114	RISAConnection cannot determine the knife plate for Connection (number)	If the knife plate is deleted or set to a thickness of 0" then this error will be generated. 
E0115	RISAConnection only supports Connection (number) with only one knife plate on each brace	In Tekla Structures it is possible to have two knife plates on a single brace. This is not supported in RISAConnection and the connection will not be transferred. 
E0116	RISAConnection only supports Connection (number) with welds between knife plate and brace	For knife-plate brace connections only the welded to the brace option is supported. 
E0117	RISAConnection only supports connection without stiffeners	Stiffeners are not available for this connection in RISAConnection. Connection is transferred without stiffeners.
E0118	Connection cannot be transferred to RISAConnection - Column and Bolts must be centered on base plate	RISAConnection base plates must be centered on the column base plate.
E0119	RISAConnection does not support horizontal, inclined or inverted base plates in Column Base Plate Connection. RISAConnection supports this connection only if the column is oriented vertically at the base	RISAConnection base plates using US Base plate (component 1047) must be oriented vertically at the base of a column. Connection is not transferred.
E0120	RISAConnection does not support Slotted hole types for single base plates in connection. Connection is not transferred. Change the hole type to Default or Oversized for transfer	Base plates in RISAConnection only support the standard (default) or oversized hole types.
E0200	Beam orientation not supported for Connection (number)	Chevron brace connections are only supported into the strong axis. Weak-axis connections will not be transferred.
E0201	Member center line must align for a valid RISAConnection	For columns the vertical (or horizontal) position must be defined as "Middle" so that the beam is centered on the column. For beams the plane position must be defined as "Middle". If these options are not set to be centered the connection will not go to RISAConnection.
E0202	Invalid member rotation for a valid RISAConnection	For girder/beam connections the girder rotation position must be "Top" or "Below". For column/beam or girder/beam connections the beam rotation position must be "Top" or "Below". If these options are set to anything else they will not go to RISAConnection.
E0203	Column orientation not supported for this connection	Column-Beam moment connections are only supported in RISAConnection if the connection is attached to the column flange.
E0204	Connection (number) is supported between column and beam connection only	Flange-plated moment connections are not supported in RISAConnection for girder/beam connections.

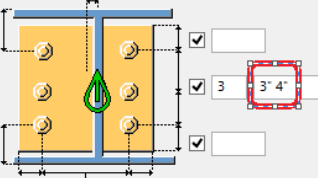
Code	Message	Explanation
E0205	"Connection (number)" is supported with 2 end plates only	End plate splice connections always require two plates, one welded to each of the attached beams/columns.
E0206	"Connection (number)" is supported between girder and beam only	This Component is only supported for girder/beam connections. If you use this Component in any other case you will likely get this error.
E0399	In "Connection (number)" the type of fasteners between the Beam and Gusset must be direct weld or double clip angle	A single clip angle is not currently allowed between the gusset and beam. 
E0400	In "Connection (number)" the type of fasteners for the Column/Gusset and Beam/Gusset connections must be explicitly defined	For vertical brace connections, if the beam/gusset and column/gusset connections are not the same (either both double clip angles or directly welded) then you must explicitly define the connectors for these connections on the Gusset conn 1 and Gusset conn 2 tabs of Component 59 and 60. 
E0401	Requested clip angle configuration is not supported by RISAConnection	If there is not a single or double clip angle configuration on this connection this message will be given. Deleting both clip angles will give this message, as will having an odd orientation of the clip angles. 
E0402	Requested bolt group configuration is not supported by RISAConnection. The bolt group is missing in "Connection (number)"	Certain bolt hole configurations in Tekla Structures (144 for example) can be non-symmetric and are not supported by RISAConnection. 
E0403	Requested shear plate configuration is not supported by RISAConnection	If certain components of the connection are removed or unsupported this message will be given. Deleting the shear tab, for example, will produce this message. Using a knife plate shear connection with an unsupported configuration will also produce this message.
E0404	Requested end plate configuration is not supported by RISAConnection	If certain components of the connection are deleted this message will be given. Deleting the bolts from the end plate to the supporting member, for example, will produce this message.
E0405	Requested moment plate configuration is not supported by RISAConnection	If certain components of the connection are deleted this message will be given. Deleting the bolts on the flange plate, for example, will produce this message.
E0407	Requested weld configuration is not supported by RISAConnection	This message will occur on connection 134 if any of the welds to the column are deleted.

Code	Message	Explanation
E0408	Requested type of connector between gusset and beam/column in "Connection (number)" is not supported by RISAConnection	<p>RISAConnection only supports beam/gusset and column/gusset connections that are double angle or directly welded. If you make any other selections this is not supported. You also must explicitly define these connections, as the default is not sufficient.</p> 
E0500	RISAConnection cannot determine fastener on the primary beam	This message will generally occur if you delete the welds/bolts to the beam.
E0501	RISAConnection cannot determine fastener on the primary column	This message will generally occur if you delete the welds/bolts to the primary column.
E0502	RISAConnection cannot determine fastener on the primary girder	This message will generally occur if you delete the welds/bolts to the girder.
E0503	RISAConnection cannot determine fastener on the secondary beam	This message will generally occur if you delete the welds/bolts to the supporting beam.
E0504	RISAConnection cannot determine fastener on secondary column	This message will generally occur if you delete the welds/bolts to the secondary column.
E0505	RISAConnection cannot determine fastener on the moment plate	This message will generally occur if you delete the welds/bolts to the moment plate.
E0506	RISAConnection supports only connections with same fasteners between beam/-column and two moment plates	For a moment plate connection, both the top and bottom flange plate must either be welded/bolted.
E0507	RISAConnection cannot determine web weld in "Connection (number)"	This will happen if odd things are happening to the component in Tekla Structures. If two parts that are supposed to be welded are not physically touching this message may occur. If individual welds are deleted this can also occur.
E0508	RISAConnection cannot determine flange weld in "Connection (number)"	This will happen if odd things are happening to the component in Tekla Structures. If two parts that are supposed to be welded are not physically touching this message may occur. If individual welds are deleted this can also occur.
E0509	RISAConnection cannot determine brace in "Connection (number)"	If the RISA-Tekla Link can not recognize the brace this message will be given.
E0510	RISAConnection cannot determine gusset in "Connection (number)"	This message will occur if you explicitly delete the gusset from a vertical brace connection.
E0511	RISAConnection cannot determine fastener on the gusset in "Connection (number)"	For gusset/beam and gusset/column connections the only two options supported in RISAConnection are directly welded or double angle. Any other selections will produce this message. You must also explicitly select the proper connection (weld/bolt, weld/weld, bolt/weld, bolt/bolt) for the gusset/beam and gusset/column connections as well.
E0512	RISAConnection cannot determine fastener on the brace in "Connection (number)"	The connector plate must pass through the tube. Cutting out the plate around the tube is not supported in RISAConnection

Code	Message	Explanation
		 <p>This message can also occur if through-bolting the gusset plate to the tube/pipe in Wraparound Gusset Cross (60) connection, as this is not supported in RISACconnection. It can also occur if the weld is not defined.</p>
E0513	RISACconnection cannot determine stiffeners in "Connection (number)"	For end plate moment connections with extensions on both beam flanges, a stiffener must occur on either both sides or neither side. If there is a stiffener on only one side then this message will occur.
E0514	RISACconnection does not support requested brace orientation from "Connection (number)"	This error will occur if a channel is used as a brace and the flange of the channel is connected to the gusset. RISACconnection only supports a condition where the web and the gusset are connected (i.e parallel to one another).
E0515	RISACconnection cannot determine clip angles for attaching brace in "Connection (number)"	If a clip angle(s) is missing from the connection between the brace and the gusset this error will occur (there must be 4). This could also occur if a plate is used on the brace flanges instead of clip angles.
E0516	Clip angle for attaching brace must be identical in "Connection (number)"	The multiple clip angles attaching the brace to the gusset must all be the same cross-section. 
E0517	RISACconnection cannot determine the connecting plate between brace and gusset in "Connection (number)"	There must be a plate connecting the web of the brace and the gusset. If this is missing this error will occur.
E0518	RISACconnection does not support the "Connection (number)" with brace angle from vertical of less than 10 degrees or greater than 85 degrees	If the brace angle exceeds these limits then the connection will not be transferred.
E0519	RISACconnection does not support the joining of pipe and clip angle in "Connection (number)"	This type of connection is not supported for round sections and  <p>thus the connection is not transferred.</p>
E0520	The fastener between Beam (in case beam shape = Tube) and Clip Angle must be weld in "Connection (number)"	RISACconnection only supports a welded connection between a clip angle and tube beam. Bolted clip angle connection is not supported.
E0521	RISACconnection does not support the "Connection (number)" with gusset that intersects the beam	RISACconnection does not currently have a chevron brace connection where the gusset acts as a knife plate through the supporting tube/pipe section. 
E0522	RISACconnection cannot determine flange plates in connection	Specify the flange plate size and material in Tekla Structures for connection to transfer to RISACconnection.
E0523	RISACconnection cannot determine base plate in connection	Designate the rectangular base plate dimensions in Tekla Structures.
E0524	RISACconnection cannot determine plate washer weld in connection	RISACconnection needs the weld size between the washer and plate washer, however this variable is not available in Tekla

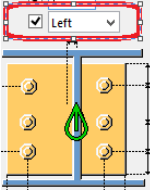
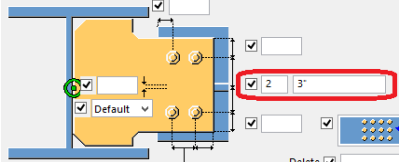
Code	Message	Explanation
		Structures. RISAConnection will use the weld between the plate washer and anchor size. See the Component Specific Considerations - Base Plates topic for further guidance.
E0525	RISAConnection cannot determine concrete support in connection	In Tekla Structures 1047 anchor rods tab, specify the concrete support and material.
E0526	The profile of anchors must be round in connection	Anchor bolts must use a round profile to transfer the bolt diameter to RISAConnection.
E1000	RISAConnection does not support 1 Clip Angle from "Connection (number)"	A clip angle beam/column connection must be a double angle (and can not be a single angle) if part of a vertical brace connection.
E1001	RISAConnection does not support 2 Shear Plate from "Connection (number)"	For shear plate connections RISAConnection can only support a single shear plate. 
E1002	RISAConnection does not support connections with this fastener between brace to the connection plate in "Connection (number)"	For the vertical brace connection with a tube or pipe using Hollow Brace Wraparound Gusset (59), the connection between the connection plate and the tube/pipe must be welded. RISAConnection does not support through bolting of this connection  . There also can only be a single connection plate in this connection 
E1004	RISAConnection does not support connections with both transverse stiffeners and doubler plates in "Connection (number)"	This is a limitation of RISAConnection. If you remove either the doubler plates or the stiffeners and send it back to RISAConnection then you can get a design.
E1005	RISAConnection does not support this location of brace in "Connection (number)"	Putting in a non-sensical value may trigger this error. A negative gap distance between gusset and brace is one example
E1012	Bolt groups must be uniform and symmetric for RISAConnection	If you delete bolts from a bolt configuration or have non-uniform vertical or horizontal spacing between bolts then you will get this message. 
E1018	RISAConnection does not support staggered bolt configuration.	Connections with bolt configurations that are not rectangular and orthogonal will not be brought into RISAConnection. 
E1019	Gusset should not be moved relative to the central axis of "Connection (number)"	RISAConnection does not allow you to shift the gusset. 
E1020	Gusset should not cut into column or beam in "Connection (number)"	If the connection is offset such that the gusset penetrates the beam or column in a vertical brace connection then this message will be given. 
E1021	Bolts must be concentric with the connection.	Where there are bolts on either side of a centerline of a connecting element the bolts must be centered on that element.

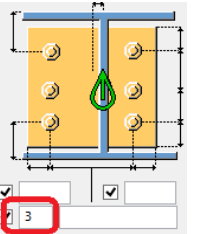
Code	Message	Explanation
		
E1024	Unsupported bolt group configuration in the flange moment plate	RISACONNECTION can only support two symmetric rows of bolts for the flange to flange plate connection. 
E1033	Both clip angles must be same for RISACONNECTION	For a double clip angle connection both clip angles must be the same size and orientation.
E1034	Material for both clip angles must be same for RISACONNECTION	For a double clip angle connection both clip angles must be the same material.
E1035	RISACONNECTION only supports connections with bolts on the beam	If the bolts are not long enough to attached to the beam then this message can occur. This does not happen by default, but it is possible to manually shorten the bolts.
E1036	RISACONNECTION only supports connections with bolts on the column/girder	If the bolts are not long enough to attached to the column then this message can occur. This does not happen by default, but it is possible to manually shorten the bolts.
E1038	Unsupported fastener type for RISACONNECTION	RISACONNECTION does not support a clip angle being both welded and bolted to a primary/secondary member. This may also occur if attempting to bolt to a tube shape. 
E1041	RISACONNECTION does not support connection with requested bolts configuration and without flange welds	Flange plates must be welded to the support and bolted to the beam flanges in RISACONNECTION.
E1042	RISACONNECTION does not support requested bolts configuration from connection from "Connection (number)"	RISACONNECTION does not support an odd number of bolts on a connection. For example, 3 columns of bolts on an end plate connection (component 144) will not work. There must be symmetry from the centerline of the connection. This message is also common with component 14 in that RISACONNECTION only supports particular bolt configurations. 

Application Interface - RISA-3D

Here we will give you a quick outline of the interface. See the [RISA-Tekla Link RISA-3D Procedure](#) more information.

Tekla Structures Interface

After the link is installed, RISA-3D will be an option in the **Analysis application** drop-down. Make sure RISA-3D is selected.

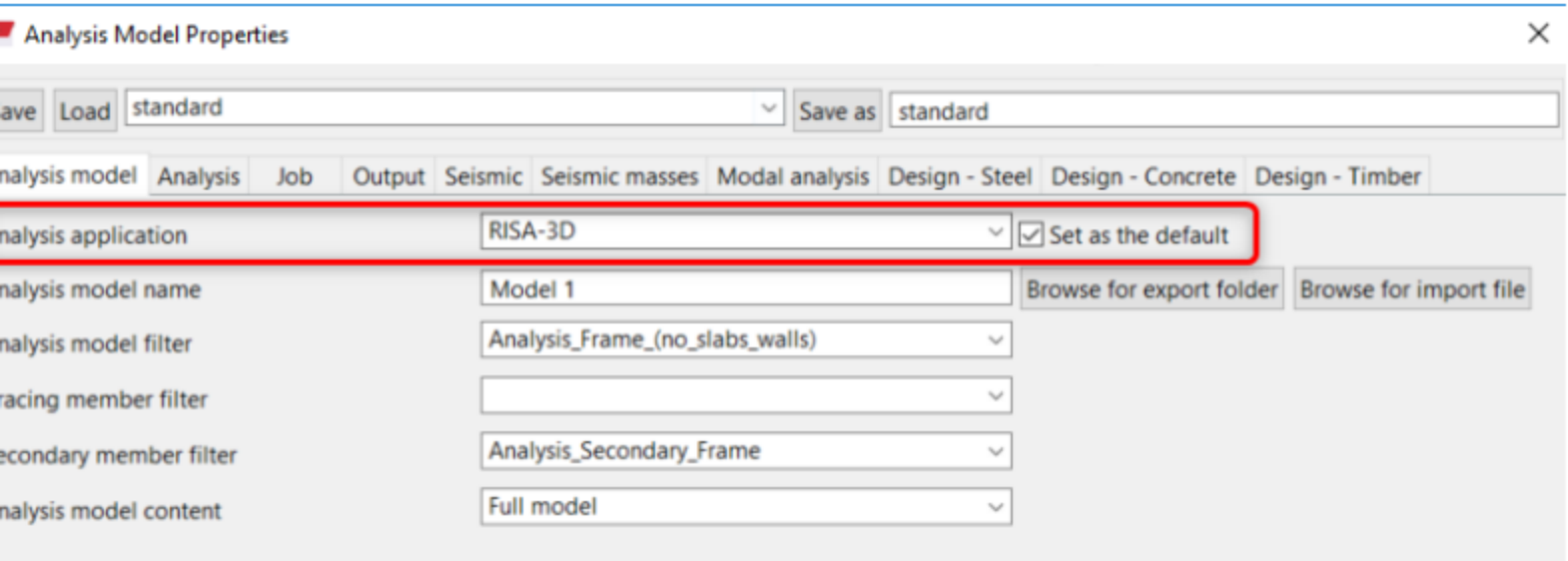

Export/Import

After clicking the **Export/Import** buttons from the Analysis & Design Models dialog, our link dialog will show.

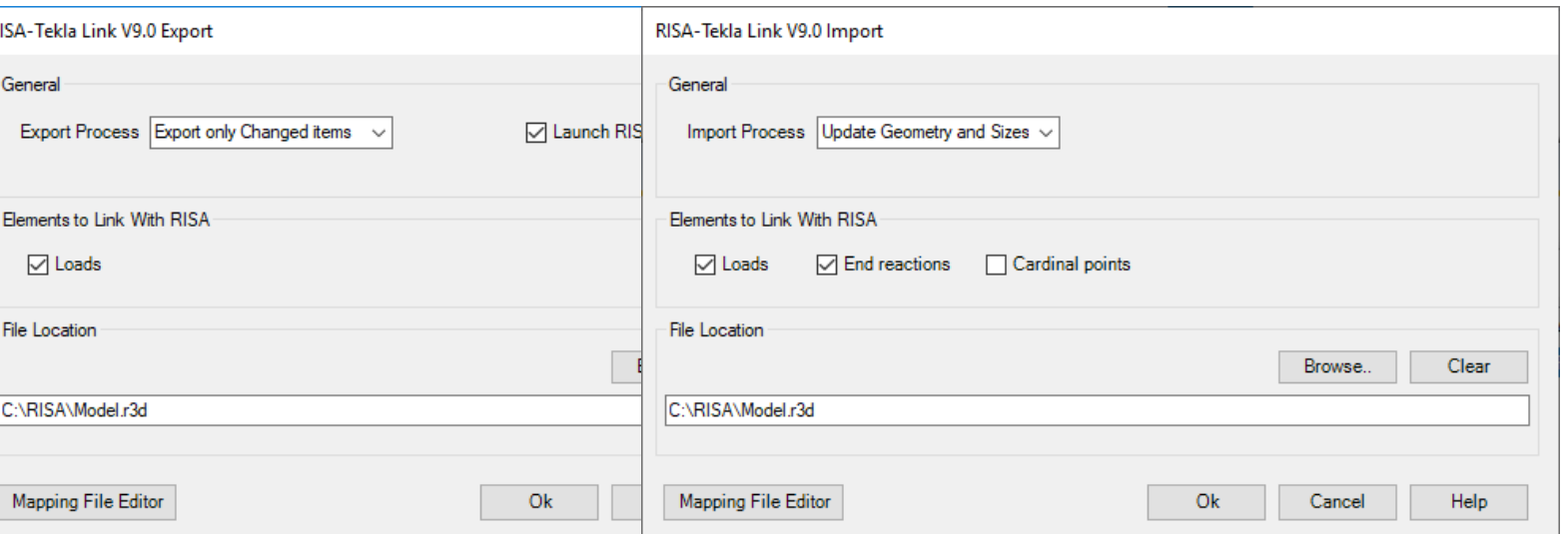

Export

Import

The **Export Process** provides options for the user to choose to export only changed items or overwrite all RISA items while exporting a Tekla Model into RISA-3D.

- The Export Only Changes Items is the default export option and will update any modifications to existing or new elements from the Tekla model.
- The Overwrite All RISA items will export all Tekla elements to RISA. This will override the previous export RISA model and create a new exchange file based on the current Tekla model.

The **Import Process** provides options for the user to choose to update geometry and sizes , update member sizes only, or overwrite Tekla elements while importing a RISA-3D model into Tekla Structures.

- The Update Geometry and Sizes is the default import option and will import all modified and/or new elements from the RISA model into Tekla.
- The Update Member Sizes Only should be used where a discrepancy between the geometry of the RISA model and the Tekla model ought to be maintained. This allows the user to speed up the import process to only update the member sizes of existing members in the Tekla model during a subsequent round-trip.
- The Overwrite all Tekla Items will remove any existing Tekla elements from the model during import and import the RISA model. (This breaks any previous round-trips and starts the user off with a freshly imported RISA model into Tekla).

The **Launch RISA Application after Export** checkbox will allow you to directly launch RISA-3D when running the link.

Note:

- Only check this checkbox if you have RISA-3D V23.0.0 or later installed.

The **Loads** checkbox allows you to transfer point and line loads.

The **End Reactions** checkbox allows you to import end reaction results from RISA-3D. Be sure to save the RISA-3D solution file to import the reaction results.

The **Cardinal Points** checkbox will import RISA-3D's cardinal points to Tekla's physical member position. When this option is checked, the RISA model may only be imported into Tekla *once* as Tekla's member position does not currently map back to RISA's cardinal points.

The **File Location** allows you to specify where you want the link to write out the exchange (and possibly the RISA-3D) file. The default location will be **Model Folder\Analysis\Analysis Model Name** but you can point this location anywhere.

The **Mapping File Editor** button opens the interface to allow you to edit the mapping of shapes and materials. Custom or uncommon shape names will need to be manually mapped. See the [Mapping Behavior](#) topic for more on this.

Export/Import Summary Report

After the link is run a dialog will open that gives any error/warning messages and gives a summary of what was imported/exported. If a member or element doesn't export/import with the link there will be an error message defining why.

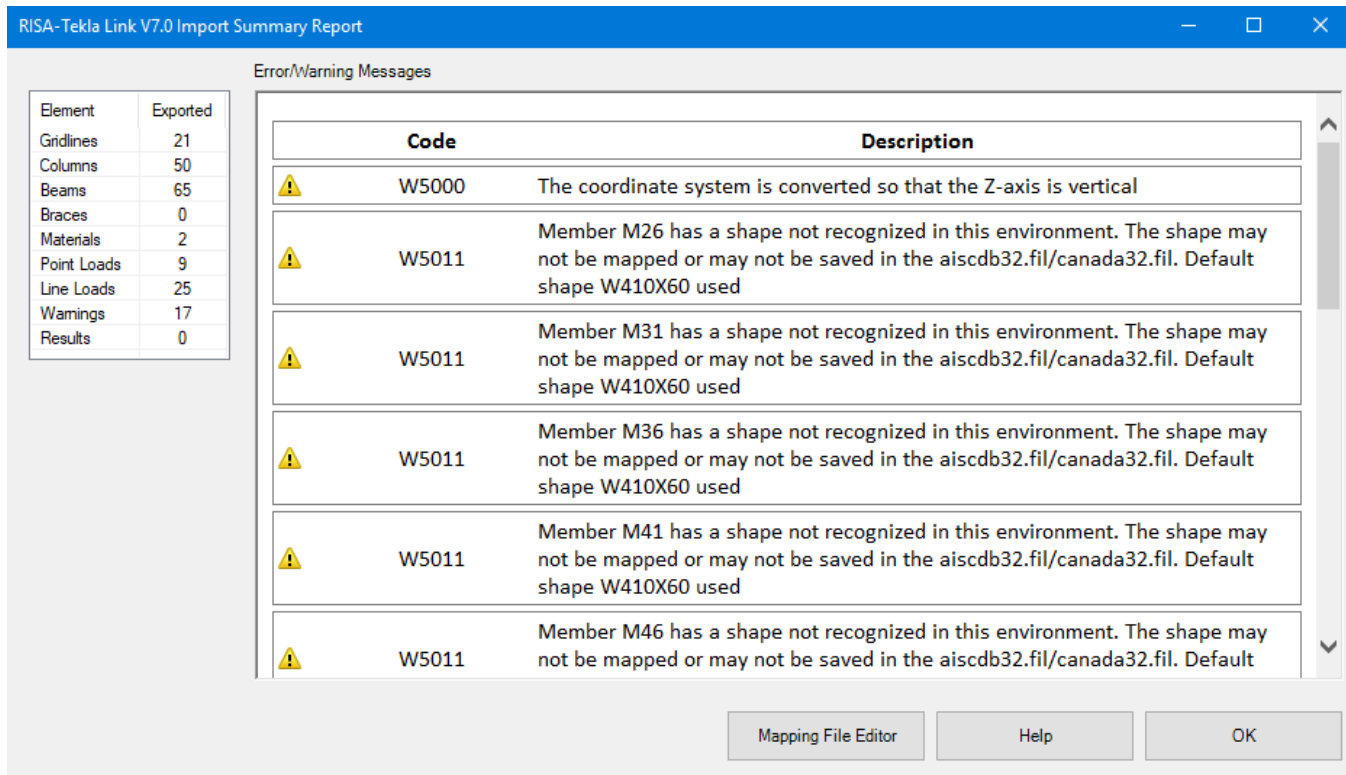

Folder Structure

When the model is transferred to RISA-3D there are two files created.

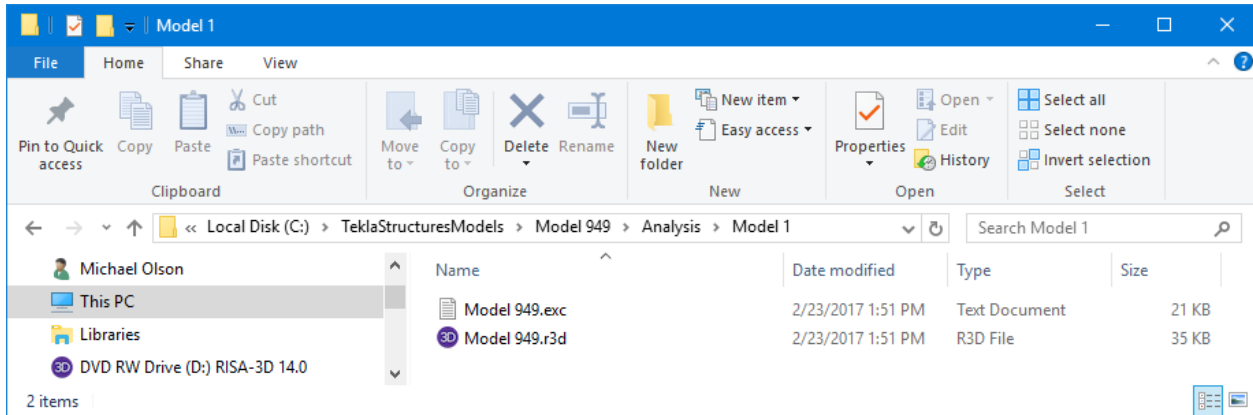

There is a ".exc" file and a ".r3d" file. The ".exc" file works as the exchange file between Tekla Structures and RISA-3D. The ".r3d" file is the RISA-3D input file. This prevents any information confusion in the link.

RISA-3D.dll

The RISA-3D/Tekla Link functionality is in the RISA-3D.dll file that is installed to C:\Program Files\Tekla Structures\Version\nt\bin\plugins\Tekla\RISA

Application Interface - RISA-3D

Here we will give you a quick outline of the interface. See the [RISA-Tekla Link RISA-3D Procedure](#) more information.

Tekla Structures Interface

After the link is installed, RISA-3D will be an option in the **Analysis application** drop-down. Make sure RISA-3D is selected.

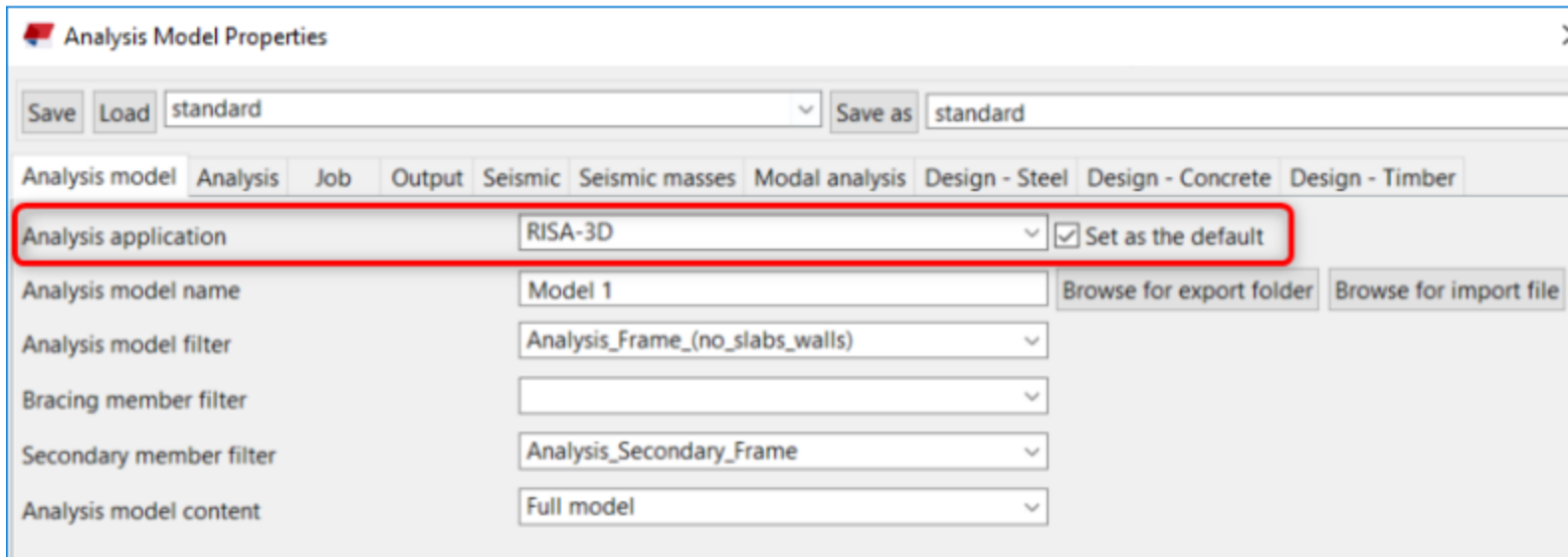

Export/Import

After clicking the **Export/Import** buttons from the Analysis & Design Models dialog, our link dialog will show.

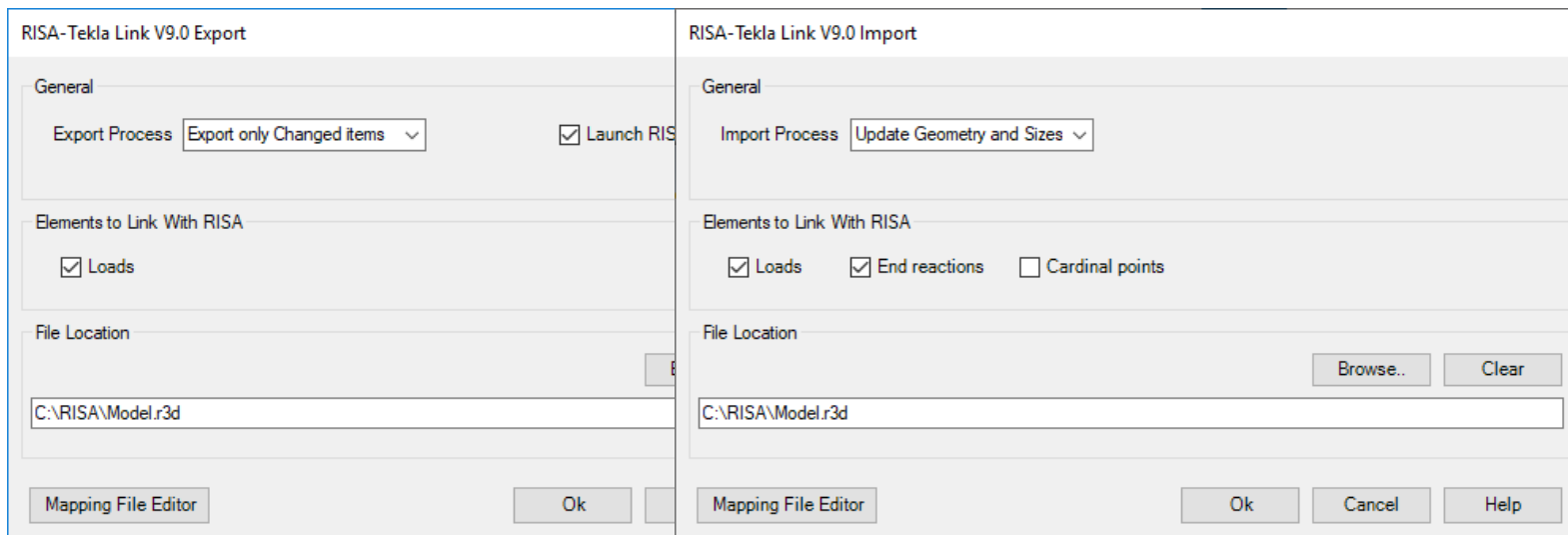

Export

Import

The **Export Process** provides options for the user to choose to export only changed items or overwrite all RISA items while exporting a Tekla Model into RISA-3D.

-
- The **Export Only Changes Items** is the default export option and will update any modifications to existing or new elements from the Tekla model.
 - The **Overwrite All RISA items** will export all Tekla elements to RISA. This will override the previous export RISA model and create a new exchange file based on the current Tekla model.

The **Import Process** provides options for the user to choose to update geometry and sizes, update member sizes only, or overwrite Tekla elements while importing a RISA-3D model into Tekla Structures.

- The **Update Geometry and Sizes** is the default import option and will import all modified and/or new elements from the RISA model into Tekla.
- The **Update Member Sizes Only** should be used where a discrepancy between the geometry of the RISA model and the Tekla model ought to be maintained. This allows the user to speed up the import process to only update the member sizes of existing members in the Tekla model during a subsequent round-trip.
- The **Overwrite all Tekla Items** will remove any existing Tekla elements from the model during import and import the RISA model. (This breaks any previous round-trips and starts the user off with a freshly imported RISA model into Tekla).

The **Launch RISA Application after Export** checkbox will allow you to directly launch RISA-3D when running the link.

Note:

- Only check this checkbox if you have RISA-3D V23.0.0 or later installed.

The **Loads** checkbox allows you to transfer point and line loads.

The **End Reactions** checkbox allows you to import end reaction results from RISA-3D. Be sure to save the RISA-3D solution file to import the reaction results.

The **Cardinal Points** checkbox will import RISA-3D's cardinal points to Tekla's physical member position. When this option is checked, the RISA model may only be imported into Tekla *once* as Tekla's member position does not currently map back to RISA's cardinal points.

The **File Location** allows you to specify where you want the link to write out the exchange (and possibly the RISA-3D) file. The default location will be **Model Folder\Analysis\Analysis Model Name** but you can point this location anywhere.

The **Mapping File Editor** button opens the interface to allow you to edit the mapping of shapes and materials. Custom or uncommon shape names will need to be manually mapped. See the [Mapping Behavior](#) topic for more on this.

Export/Import Summary Report

After the link is run a dialog will open that gives any error/warning messages and gives a summary of what was imported/exported. If a member or element doesn't export/import with the link there will be an error message defining why.

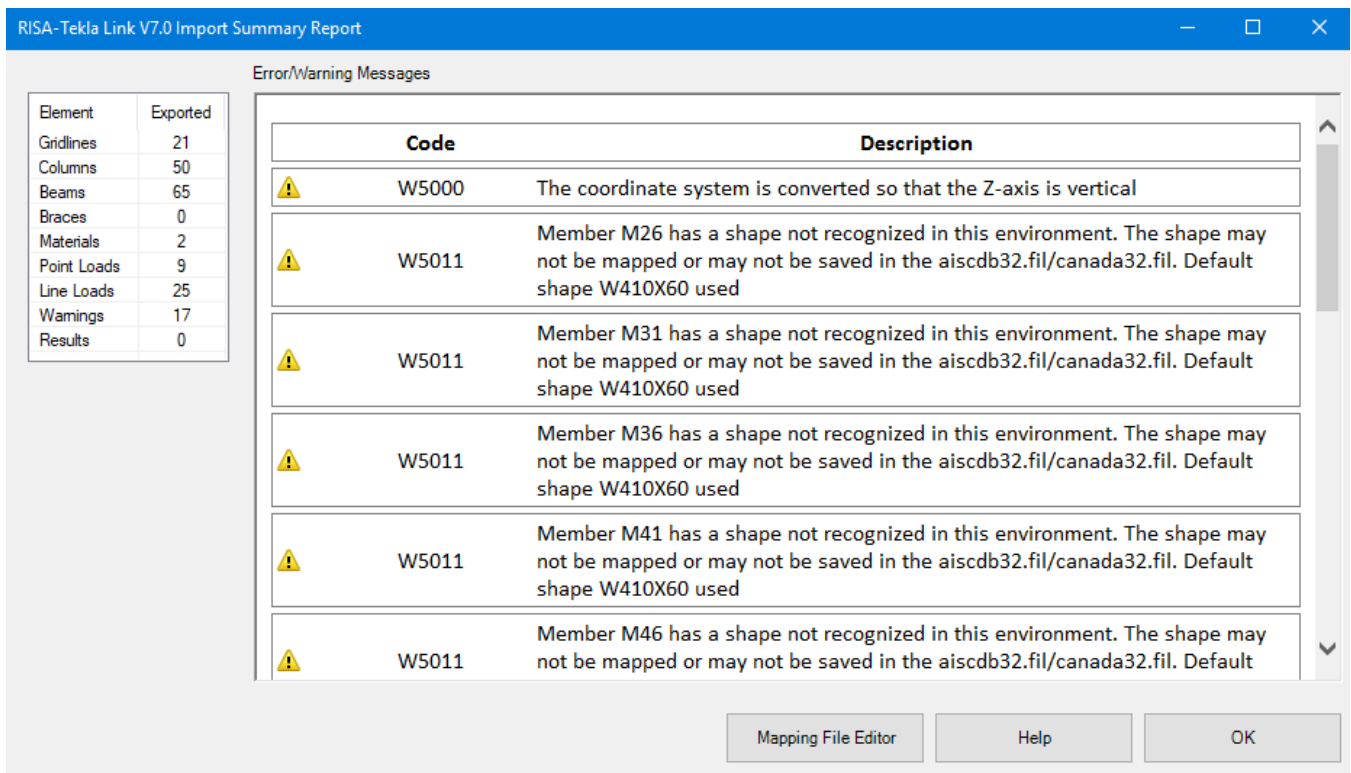

Folder Structure

When the model is transferred to RISA-3D there are two files created.

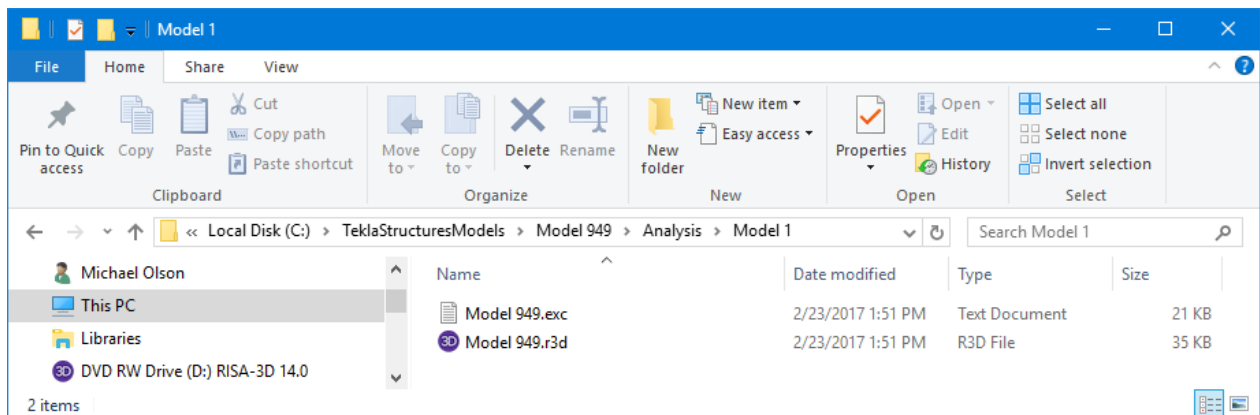

There is a ".exc" file and a ".r3d" file. The ".exc" file works as the exchange file between Tekla Structures and RISA-3D. The ".r3d" file is the RISA-3D input file. This prevents any information confusion in the link.

RISA-3D.dll

The RISA-3D/Tekla Link functionality is in the RISA-3D.dll file that is installed to C:\Program Files\Tekla Structures\Version\nt\bin\plugins\Tekla\RISA

RISA-3D/Tekla Link Integration Procedure

The RISA-Tekla link sends the geometry, materials, shape types, boundary conditions, end releases, design parameters and loading automatically to/from Tekla Structures into RISA-3D. This allows you to perform a one-way transfer of information between RISA-3D and Tekla.

Here we will walk through the steps required to both export and import a model in Tekla Structures.

Export from Tekla Structures to RISA-3D

1. Creating the Tekla Structures Analysis Model

You must first create a complete analysis model in Tekla Structures, including applying any loading, boundary conditions, end releases, design parameters, loading, etc. that you wish to transfer from Tekla to RISA-3D.

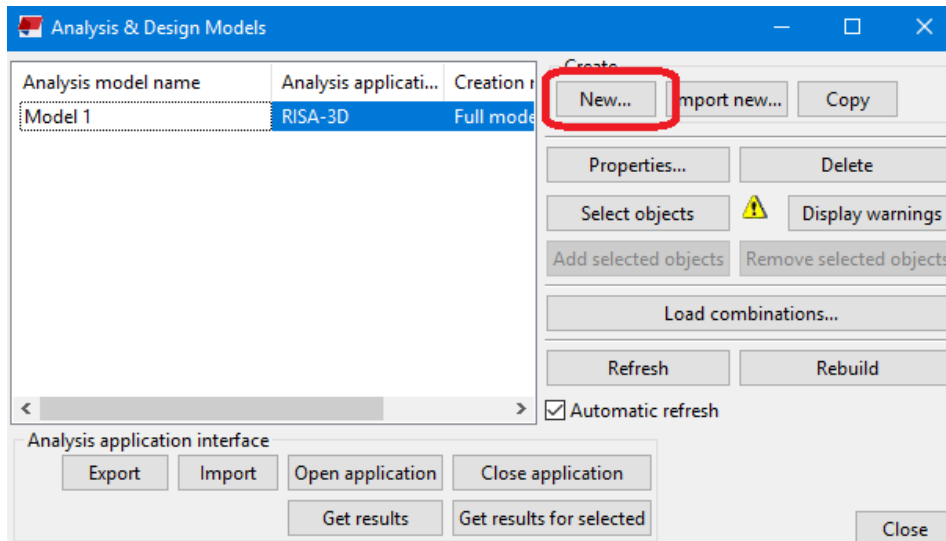
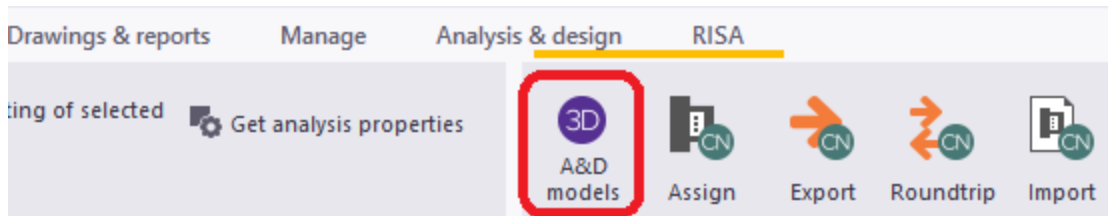

2. Setting the Analysis Application to RISA-3D and Defining your Creation Method.

Make sure to choose RISA-3D as the Analysis application and choose whether you want the Full Model or By selected parts and loads.

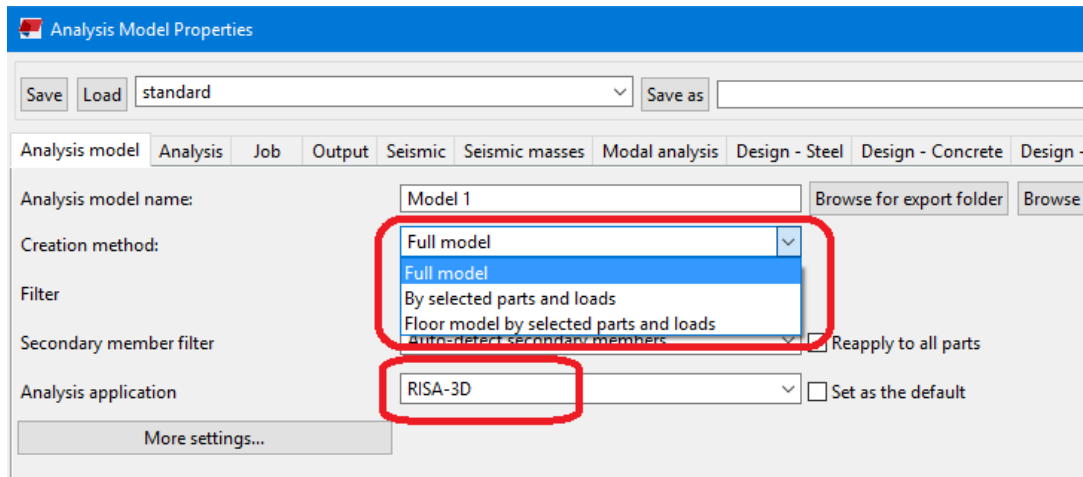

3. Verify the Analysis Model

Before exporting double-check the analysis model. Specifically:

- Check connectivity of the analysis model. Make sure beams frame into columns properly. If there is a gap in the analysis model there will be a gap when you transfer to RISA-3D and you will have solution problems.

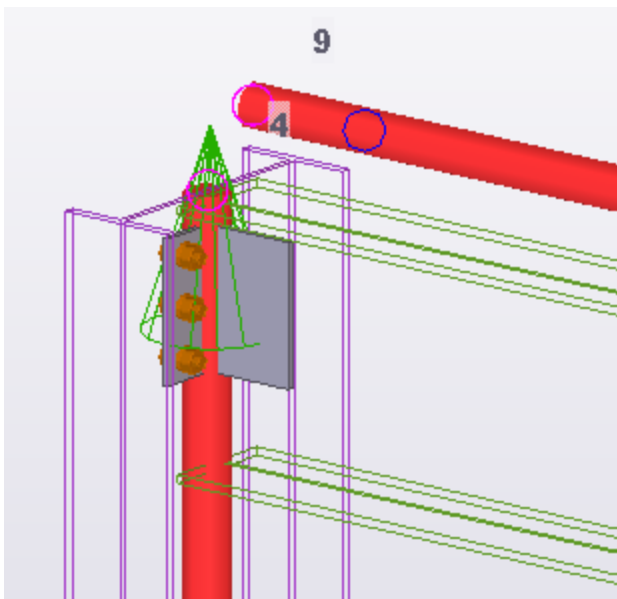

Poor Connectivity

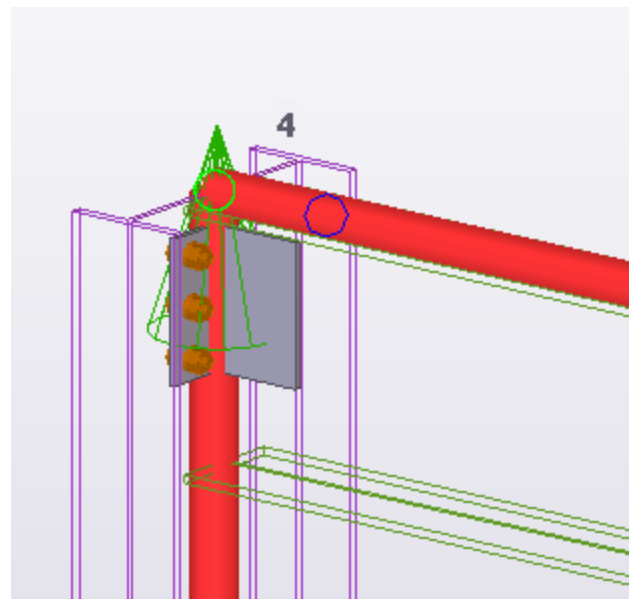

Good Connectivity

Make sure to only transfer structural elements to RISA-3D. Any miscellaneous steel should either:
Be deleted from the analysis model. This is done by clicking on the analytical member and pressing Delete.

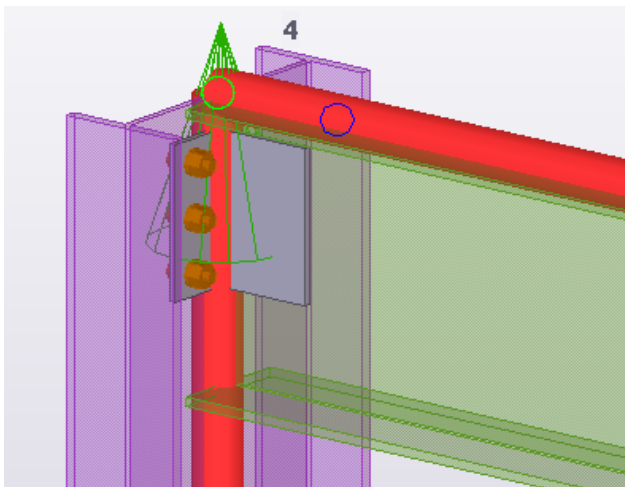

Beam Before

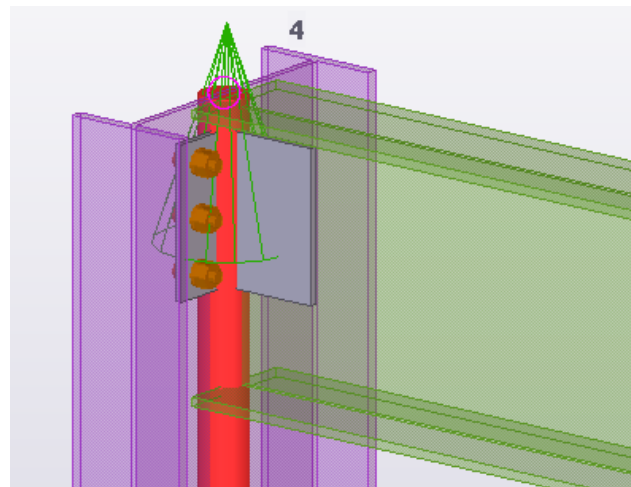

Beam After

The element should be defined with a **Class of XX - Ignore** (double-click an analytical member to view its properties).

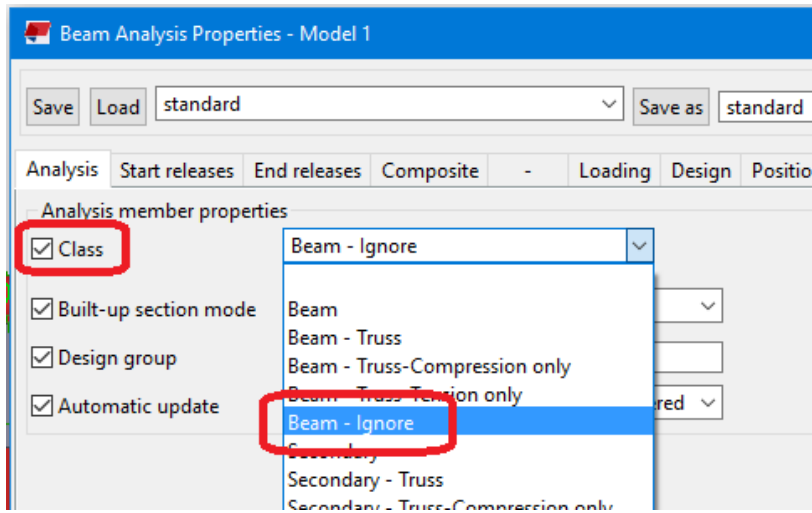

4. Export the Model

Click **Export**.

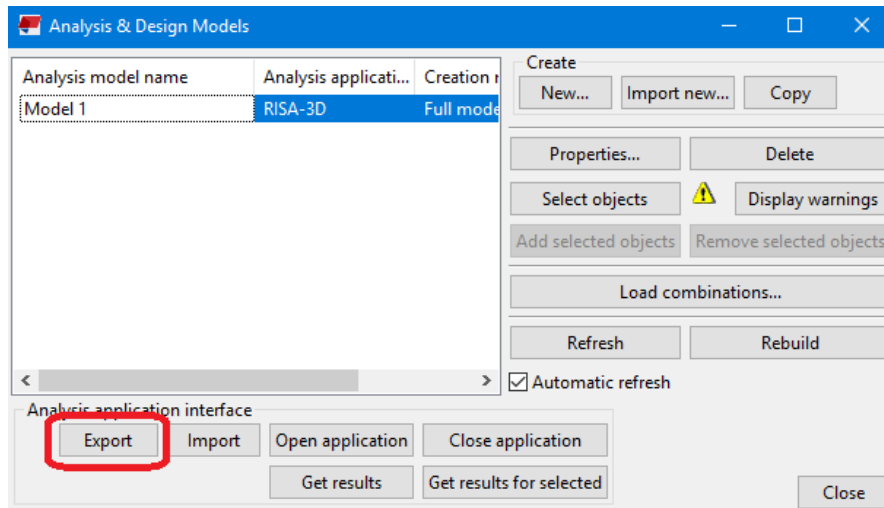

Choose the File Location (or use the default) and press **OK**.

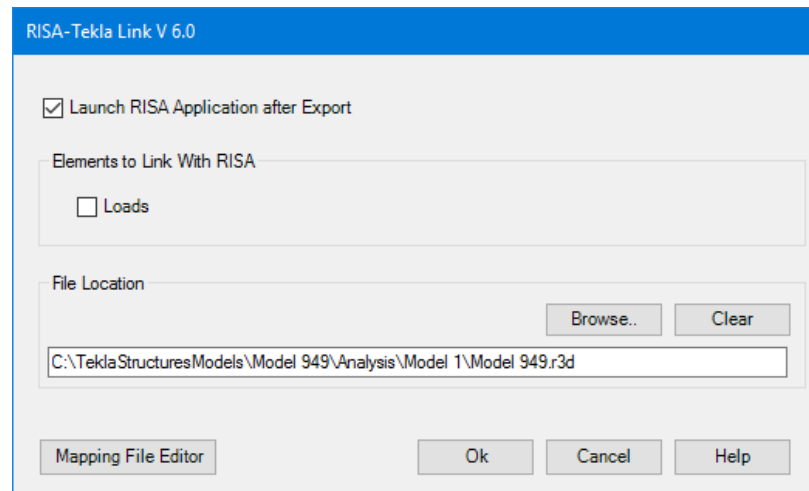

If you have RISA-3D installed on this machine check the **Launch RISA Application** after Export checkbox.

5. View the Export Summary Dialog

This dialog will give a summary of elements exported, as well as give any errors or warnings that occurred with the export.

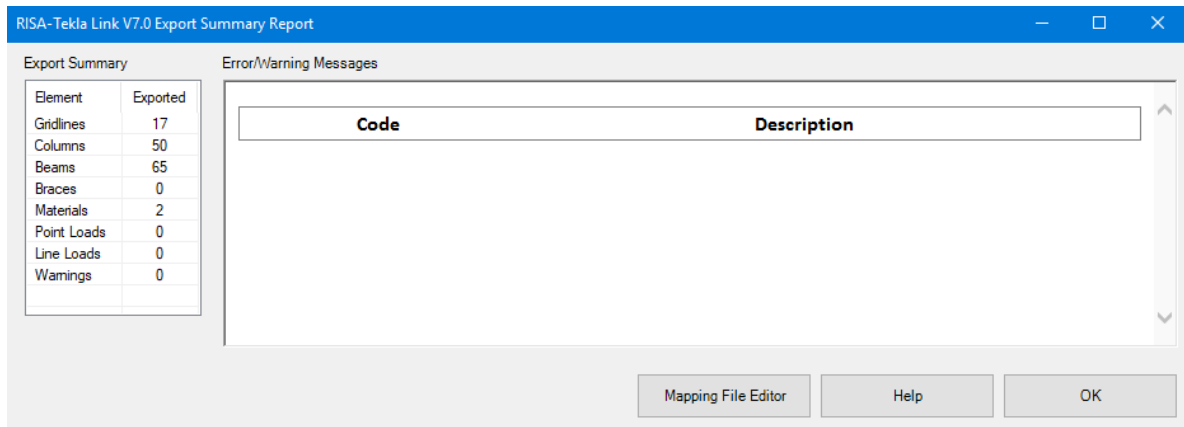

6. View the RISA-3D Model

If the **Launch RISA Application** checkbox was checked then RISA-3D will open automatically. If not then an exchange file will have been created (.exc extension).

From RISA-3D go to **File > Import > Tekla Structures Exchange File** and navigate to the .exc file.

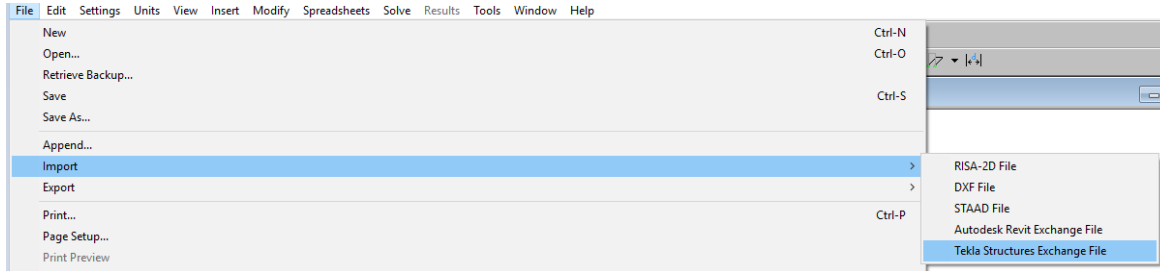

Import from RISA-3D to Tekla Structures

1. Create and Solve the RISA-3D (.r3d) Model and Save Results (.__s).

At solution the program will calculate the member end reactions. These will be saved in the results file when you save results.

2. Create and Save a Blank Tekla Structures File.

Note that any existing elements in the file will be deleted when you import the RISA-3D model.

3. Generate an Analysis Model and Press Import.

Choose **RISA-3D** as the **Analysis application**, say **OK**, and then press the **Import** button.

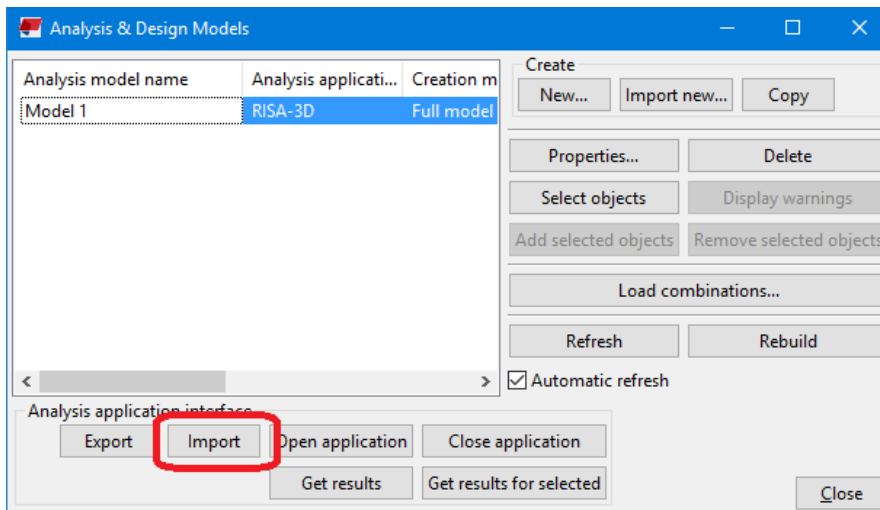

4. Choose RISA-3D File and Click OK.

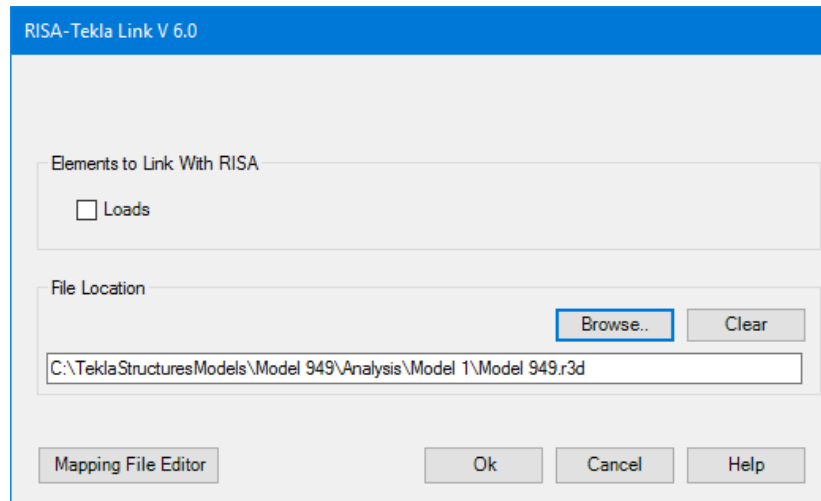

5. View the Import Summary Dialog

View this dialog to see the **Export Summary** and the **Error & Warning Messages**.

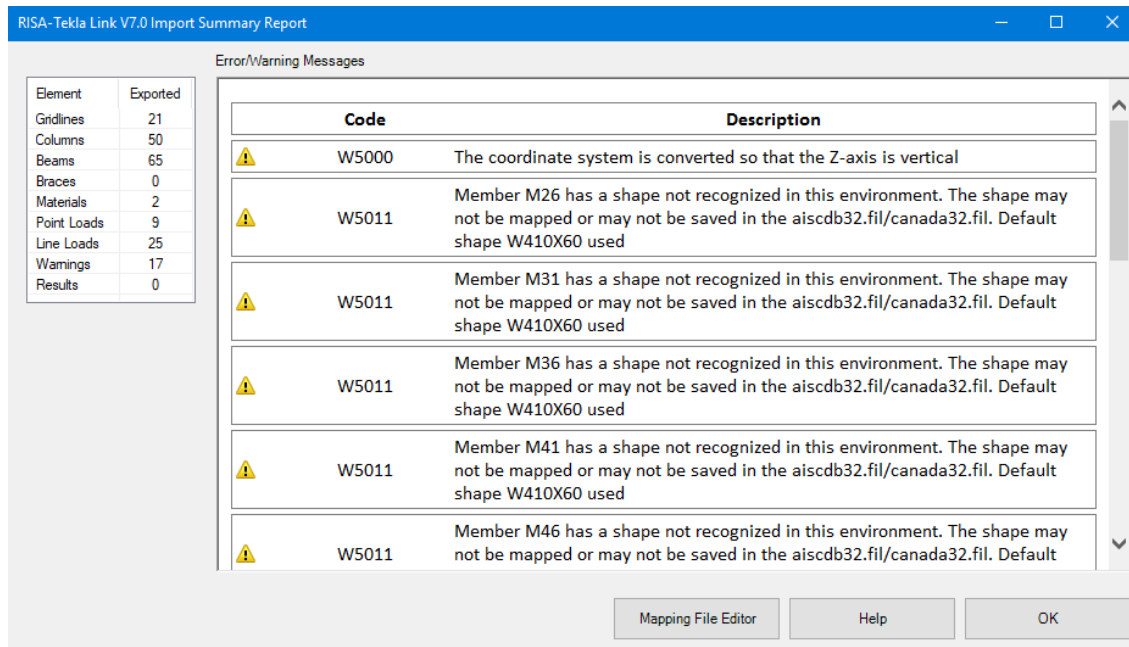

RISA-3D Behavior with a Tekla Structures Model

When transferring Tekla Structures between RISA-3D the link is transferring specific information. Here we will lay out the different considerations the link makes when transferring information.

To learn the steps of taking the Tekla Structures model to/from RISAConnection, view the [Tekla RISAConnection Procedure](#) topic.

Round-tripping between Tekla Structures and RISA-3D.

The RISA-Tekla Link V8.0 added round-tripping capabilities between RISA-3D and Tekla Structures. When a Tekla analysis model is exported to RISA-3D, a link is formed between the elements in each program. The link creates an exchange file which allows seamless integration between both programs, passing information back and forth at will between RISA-3D and Tekla Structures. The exchange file handles the bookkeeping between the two models. For this reason, it is important to always use the same exchange file when transferring back and forth multiple times (round-tripping). Whenever an exchange file is exported and overwrites a previous version of the exchange file, it is actually a merge of new data into the existing exchange file. This allows the link to identify members which have been modified, added, or deleted from a previous import.

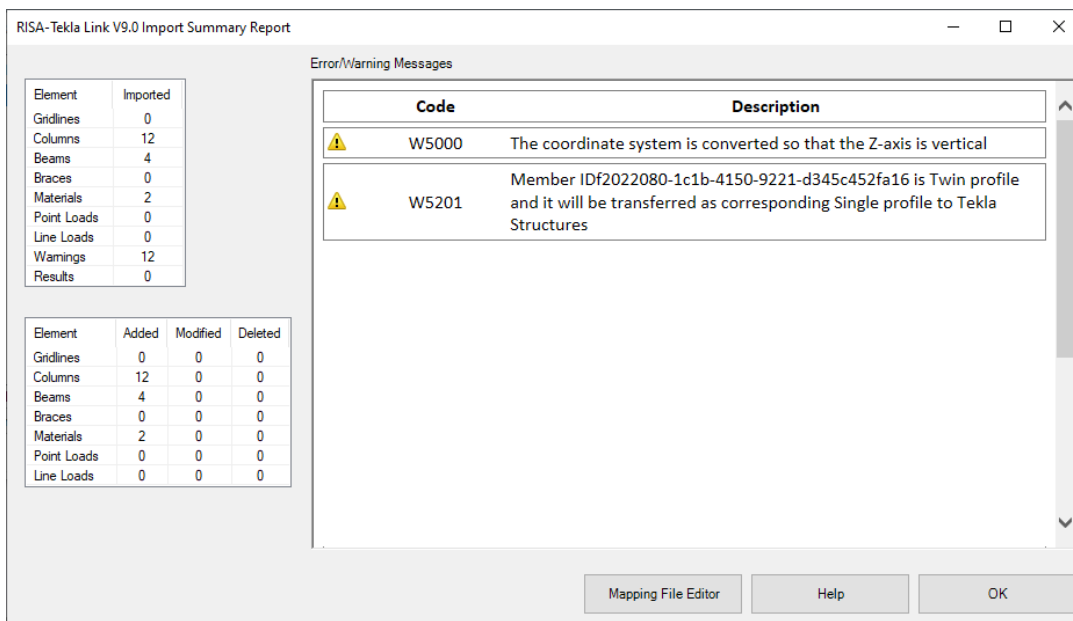

Shape & Geometry Behavior

Shape mapping is done solely through the **Mapping File Editor**. See the [Mapping Behavior](#) topic for more information. The geometry uses the Analysis Model in Tekla Structures directly. Here are some specifics of the different aspects.

Notes:

- The RISA-Tekla Link does not support parametric profiles. It only supports static profiles. If a Tekla Structures model contains a parametric profile, a warning will be given and a default section/shape will be used.
- The RISA-Tekla Link does not support pipe online shapes from RISA-3D (PI12x0.5 for example). If RISA-3D model contains an online shape a warning will be given and a default section/shape will be used.
- Only hot-rolled shapes are supported.

Shape Type Mapping

Tekla Structures and RISA both have a shape type. In Tekla Structures this is referred to as the **Class**. In RISA-3D this is referred to as the **Type**.

Tekla Structures

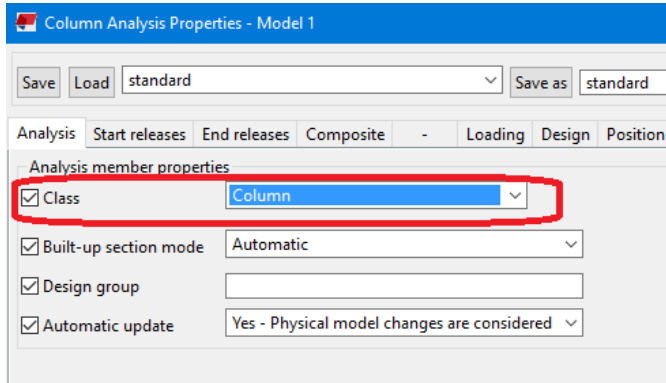

RISA-3D

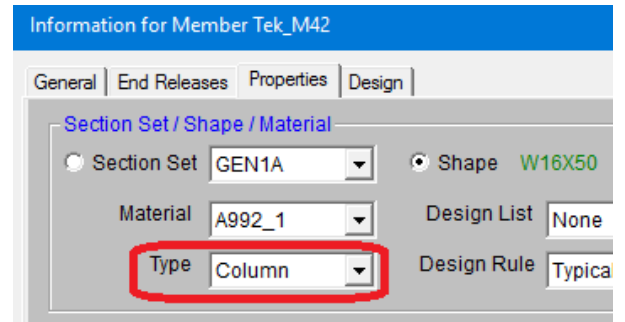

The mapping is as follows

Tekla Structures	RISA-3D
Column (including any Column - XX)	Column
Beam (including any Beam - XX)	Beam
Secondary (including any Secondary - XX)	VBrace
Any Other Selection	Beam

Member Orientation

Tekla Structures and RISA-3D define their member orientations as shown in the images below. In Tekla Structures this is the **Rotation** field. In RISA-3D this is the **x-Axis Rotate** field.

Tekla Structures

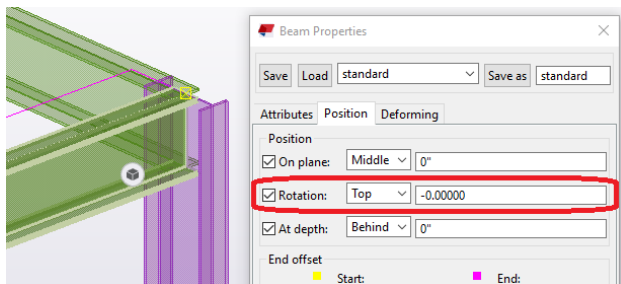

RISA-3D

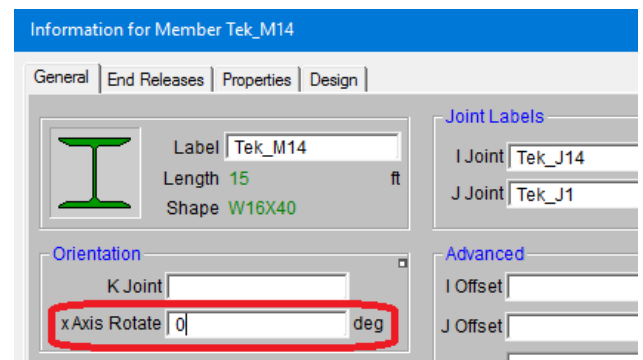

The mapping is as follows:

Columns

Tekla Structures Rotation	RISA-3D - x-Axis Rotate
Top = 0	270
Front = 0	180
Below = 0	90
Back = 0	0
Non-Zero Value	Interpolation

Beams/Braces/Secondary

Tekla Structures Rotation	RISA-3D - x-Axis Rotate
Top = 0	0
Front = 0	270
Below = 0	180
Back = 0	90
Non-Zero Value	Interpolation

Note:

- The K-Joint input is not currently supported when importing a RISA-3D model into Tekla Structures.

Analysis Member Alignment (Analytical Model)

RISA-3D defines members by their analytical member centerline for structural analysis and design. The RISA-Tekla Link round-trips models using the analytical member alignment from Tekla's analysis model.

Detailing Member Alignment (Physical Model)

In Tekla, the physical member represents the member's alignment with how it will be constructed in reality for detailing purposes. While RISA-3D does not use a physical model for structural analysis or design, RISA-3D has the option to specify a physical member's **Cardinal Point** alignment, which will map to Tekla's physical member's position.

RISA-3D's Cardinal Points

A detailing layer has been built in RISA-3D that lets the user set the "true" elevations and locations start/end, top of steel, etc...) for all members. For each member, a new data structure has been added to describe the connection point at member ends. For each end of the member, both cardinal point positions and decimal local offsets are used to describe the connection location. Only cardinal points 1-10 are supported by RISA-3D and they will only transfer to Tekla as a *one-way* integration between programs. The location of the **cardinal point** is plotted as follows:

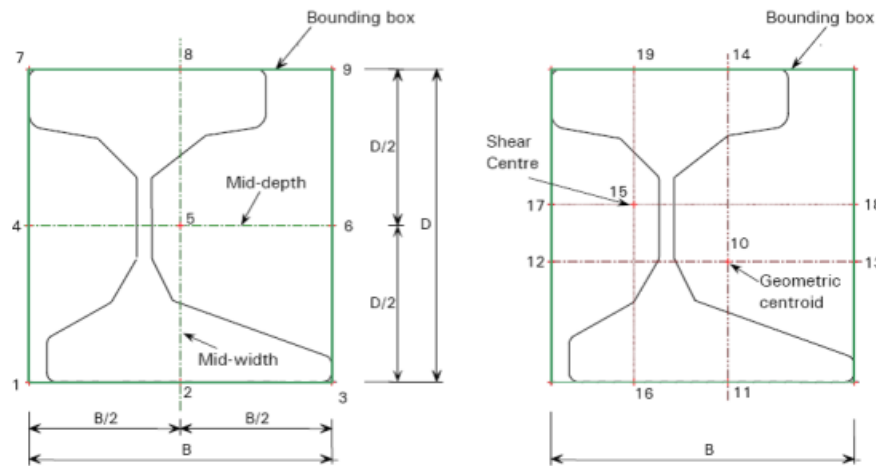

These cardinal points are used to map with Tekla's member position when a RISA-3D model is imported into Tekla:

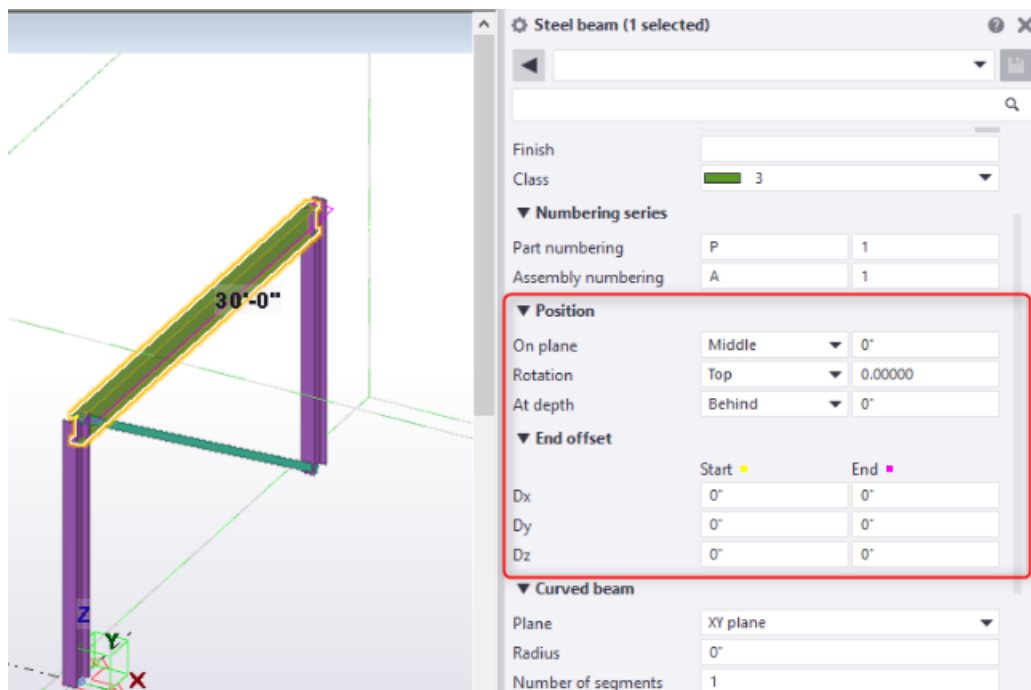

RISA-3D's cardinal points will map to Tekla's member position as follows for **beams**:

- **Cardinal point 1:** lower left corner of the member section bounding box
 - Physical On Plane: Left
 - Physical At Depth: Front
- **Cardinal point 2:** lower center point in the member section bounding box
 - Physical On Plane: Middle
 - Physical At Depth: Front
- **Cardinal point 3:** lower right corner of the member section bounding box
 - Physical On Plane: Right
 - Physical At Depth: Front
- **Cardinal point 4:** mid-depth left point in the member section bounding box
 - Physical On Plane: Left
 - Physical At Depth: Middle

- **Cardinal point 5:** mid-depth center point in the member section bounding box
 - Physical On Plane: Middle
 - Physical At Depth: Middle
- **Cardinal point 6:** mid-depth right point in the member section bounding box
 - Physical On Plane: Right
 - Physical At Depth: Middle
- **Cardinal point 7:** upper left corner of the member section bounding box
 - Physical On Plane: Left
 - Physical At Depth: Bottom
- **Cardinal point 8:** upper center point in the member section bounding box
 - Physical On Plane: Middle
 - Physical At Depth: Bottom
- **Cardinal point 9:** upper right corner of the member section bounding box
 - Physical On Plane: Right
 - Physical At Depth: Bottom
- **Cardinal point 10:** Geometric centroid of the member section
 - Physical On Plane: Middle
 - Physical At Depth: Middle

RISA-3D's cardinal points will map to Tekla's member position as follows for **columns**:

- **Cardinal point 1:** lower left corner of the member section bounding box
 - Physical Vertical: Down
 - Physical Horizontal: Right
- **Cardinal point 2:** lower center point in the member section bounding box
 - Physical Vertical: Down
 - Physical Horizontal: Middle
- **Cardinal point 3:** lower right corner of the member section bounding box
 - Physical Vertical: Down
 - Physical Horizontal: Left
- **Cardinal point 4:** mid-depth left point in the member section bounding box
 - Physical Vertical: Middle
 - Physical Horizontal: Right
- **Cardinal point 5:** mid-depth center point in the member section bounding box
 - Physical Vertical: Middle
 - Physical Horizontal: Middle
- **Cardinal point 6:** mid-depth right point in the member section bounding box
 - Physical Vertical: Middle
 - Physical Horizontal: Left
- **Cardinal point 7:** upper left corner of the member section bounding box
 - Physical Vertical: Up
 - Physical Horizontal: Right
- **Cardinal point 8:** upper center point in the member section bounding box
 - Physical Vertical: Up
 - Physical Horizontal: Middle
- **Cardinal point 9:** upper right corner of the member section bounding box
 - Physical Vertical: Up
 - Physical Horizontal: Left
- **Cardinal point 10:** Geometric centroid of the member section
 - Physical Vertical: Middle
 - Physical Horizontal: Middle

Default

When a member is drawn, by default, x offsets are set to be 0 on both ends. If the member type is beam, by default the y and z detailing offsets will be on cardinal point 8 (top center) for both ends. If the member type is column, by

default the detailing offset will be on cardinal point 10 for both ends. When a cardinal point is picked, the value in the “y Offset” and “z Offset” will automatically be updated.

Note:

- The x, y, and z offsets are based on the local axis of the member. The x local axis is defined along the member from I to J. It coincides with the geometric centroid of the member section. The standard cardinal point positions (1-10), as well as the decimal local offsets are both supported in current detailing definition.
- The Analysis Offset and Rigid End Offset are completely different concepts from the detailing offset. The purpose of the detailing offsets is more realistic visualization and plotting of the model. The detailing offsets are not considered during the analysis. In the analysis, all members are still connected at their geometric centroid. Analysis Offset and Rigid End Offsets, on the other hand, affect the load distribution and design of the member. They are analysis parameters. In RISA-3D, the Analysis Offset/ Rigid End Offset are completely separate data structure from the detailing offsets. When Analysis Offset is set for a model, for example, the detailing information will NOT automatically update the cardinal point accordingly.
- When Cardinal Points is checked while importing a RISA-3D model into Tekla, the user may currently only import the RISA-3D model into Tekla once. Tekla's physical member position does not transfer to RISA-3D's cardinal points at this time, thus round-tripping capabilities are currently not supported with the use of Cardinal Points.

Detailing Input and Modification:

To see the member detailing information in RISA-3D, you must turn on Win32 Detailing Information. This information is turned on in the Application Settings- General “Show detailing information”.

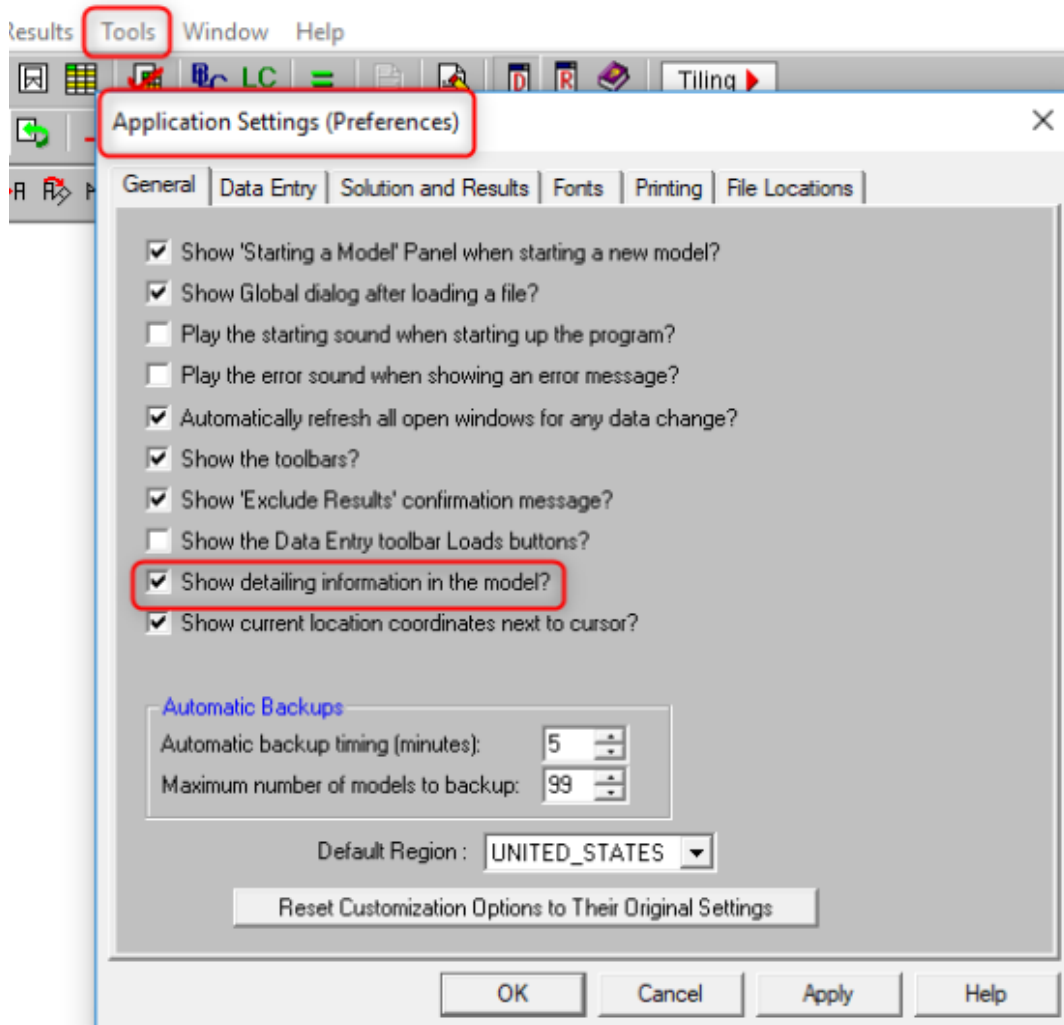

There are three ways for setting and modifying the detailing layer information:

- Members Data Entry Spreadsheet>Detailing tab
- Double-clicking Individual Member>Detailing tab
- Graphic Member Drawing>Member Detailing tab

3D Member Detailing Data										
Primary Advanced Hot Rolled Cold Formed Wood Concrete Beam Concrete Column Aluminum Stainless RISACONNECTION Detailing										
	Label	I Cardinal Point	I x Offset[in]	I y Offset[in]	I z Offset[in]	J Cardinal Point	J x Offset[in]	J y Offset[in]	J z Offset[in]	
1	M1	8	0	6.15	0	8	0	6.15	0	
2	M2	10	0	0	0	10	0	0	0	
3	M3	10	0	0	0	10	0	0	0	
4	M4	4	0	.92	-1.08	4	0	.92	-1.08	

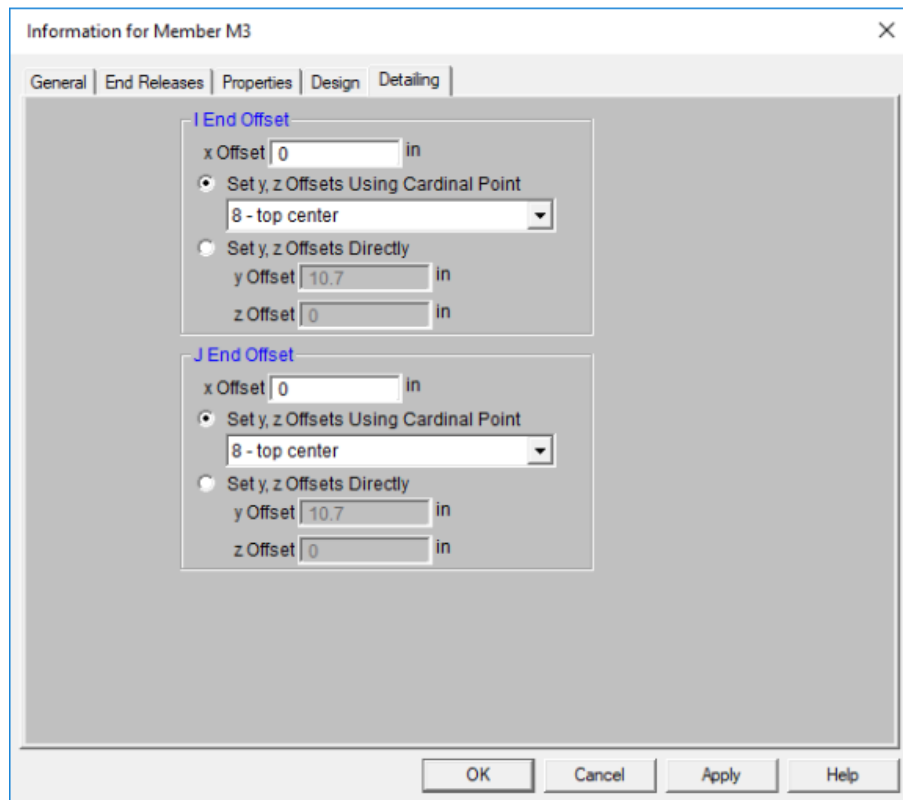

When viewing the rendered view, the option to view the detailing alignment from the cardinal points can be turned on in the Model Display Options:

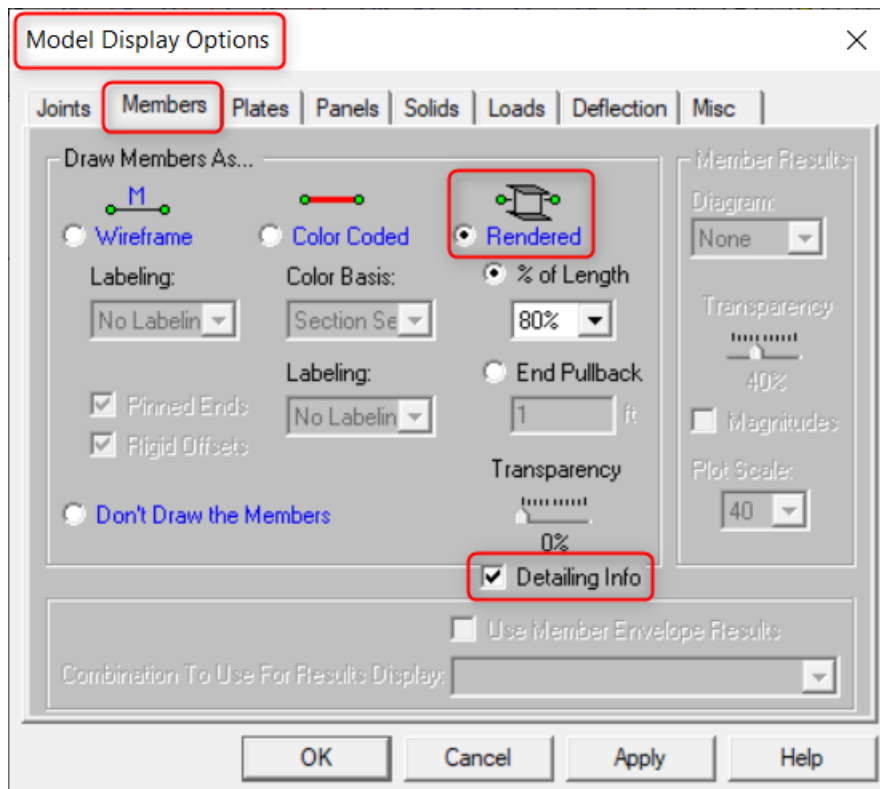

Example: Detailing Info NOT displayed

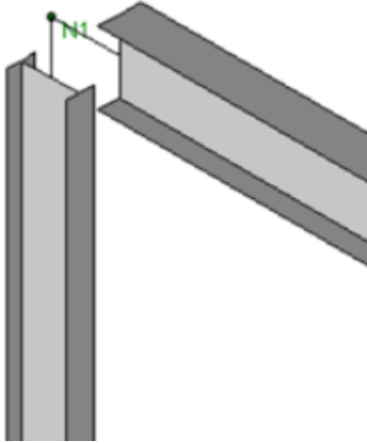

Example: Detailing Info displayed

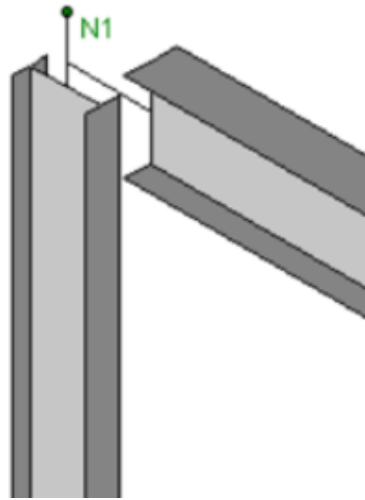

Note that the physical member drops down by half its depth.
This will match the physical model in Tekla.

Twin Profile Mapping

The RISA-Tekla Link does not support Twin Profiles at this time is currently a program limitation.

Rigid Links

The RISA-Tekla Link supports rigid links. Analytical nodes in Tekla are linked to rigid links in RISA-3D. Rigid links may originate in RISA-3D and be imported into Tekla. Alternatively, analytical nodes may be drawn in Tekla and at which point it can round-trip to RISA-3D and be mapped as a rigid link.

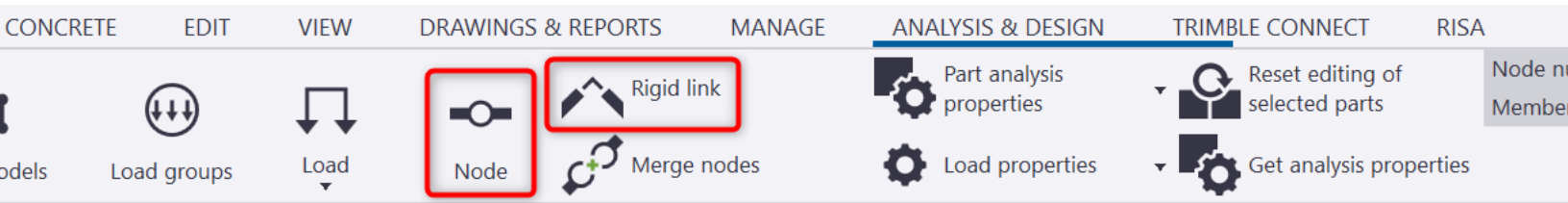

C 2

RISA-3D

Tekla Structures

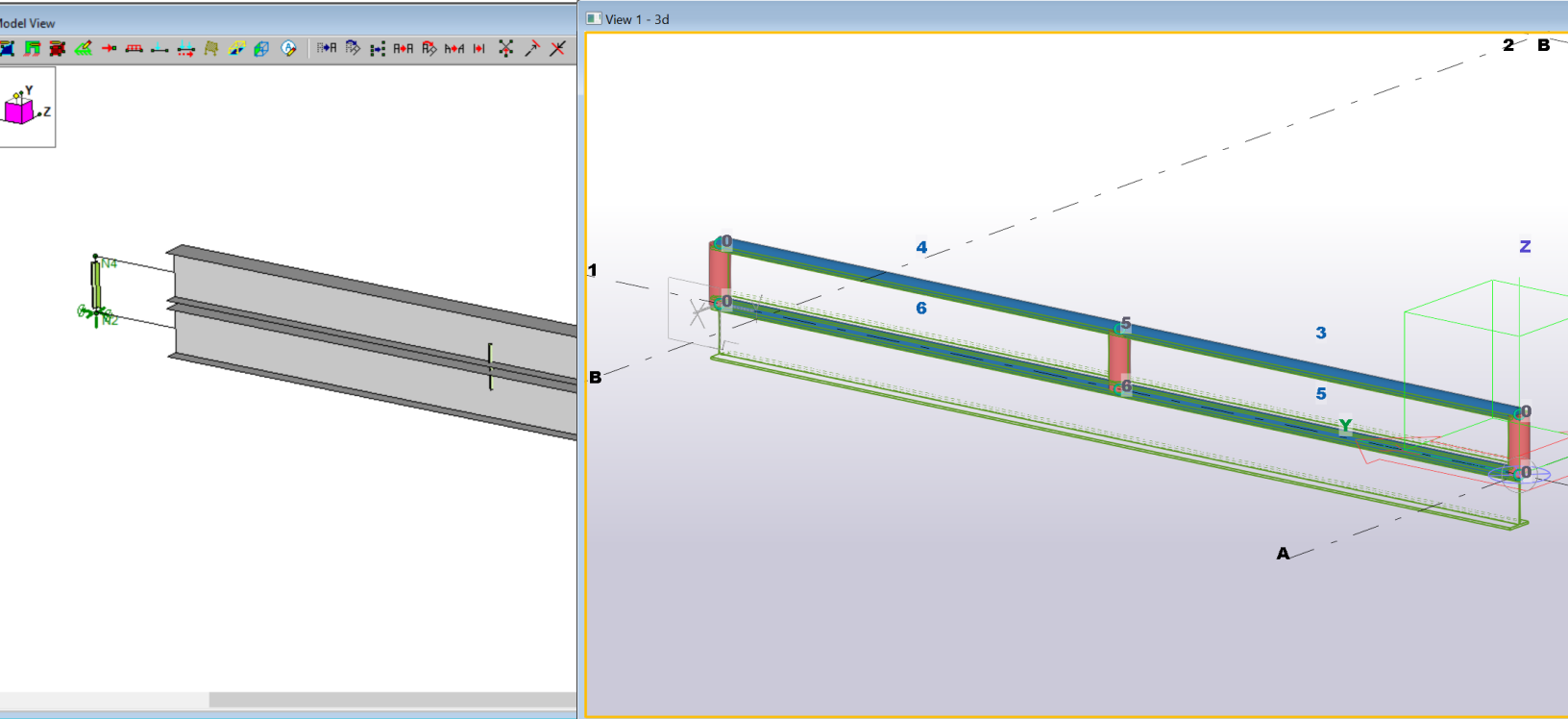

Material Behavior

Export

When exporting from Tekla Structures to RISA-3D the link will bring over directly any steel materials that are used by members in the Tekla Structures model. These materials are directly added to the Materials > Hot Rolled tab and no mapping is done. These materials are added below the existing materials in this spreadsheet.

3D Hot Rolled Steel Properties											
Hot Rolled Cold Formed Wood Concrete Masonry Aluminum General											
	Label	E [ksi]	G [ksi]	Nu	Therm (1E5 F)	Density[k/ft^3]	Yield...	Ry	Fu[ksi]	Rt	
1	A992	29000	11154	.3	.65	.49	50	1.1	65	1.1	
2	A36 Gr.36	29000	11154	.3	.65	.49	36	1.5	58	1.2	
3	A572 Gr.50	29000	11154	.3	.65	.49	50	1.1	65	1.1	
4	A500 Gr.B RND	29000	11154	.3	.65	.527	42	1.4	58	1.3	
5	A500 Gr.B Rect	29000	11154	.3	.65	.527	46	1.4	58	1.3	
6	A53 Gr.B	29000	11154	.3	.65	.49	35	1.6	60	1.2	
7	A1085	29000	11154	.3	.65	.49	50	1.4	65	1.3	
8	A500-GR.C-46	28992.453	11154	.3	0	.49	36	1.5	50	1.2	
9	A500-GR.C-50	28992.453	11154	.3	.65	.49	36	1.5	50	1.2	
10	A653	28992.453	11154	.3	0	.49	36	1.5	50	1.2	
11	A572-GR.55	28992.453	11154	.3	.65	.49	36	1.5	50	1.2	
12	A36	28992.453	11154	.3	.65	.49	36	1.5	50	1.2	
13	A572-GR.50	28992.453	11154	.3	.65	.49	36	1.5	50	1.2	
14	A992_1	28992.453	11154	.3	.65	.49	36	1.5	50	1.2	
15	A1085_1	28992.453	11154	.3	0	.49	36	1.5	50	1.2	

Import

When importing from RISA-3D to Tekla Structures the link will only directly map materials that have either the default RISA-3D materials or materials that have the exact same Label in RISA-3D as is given in Tekla Structures.

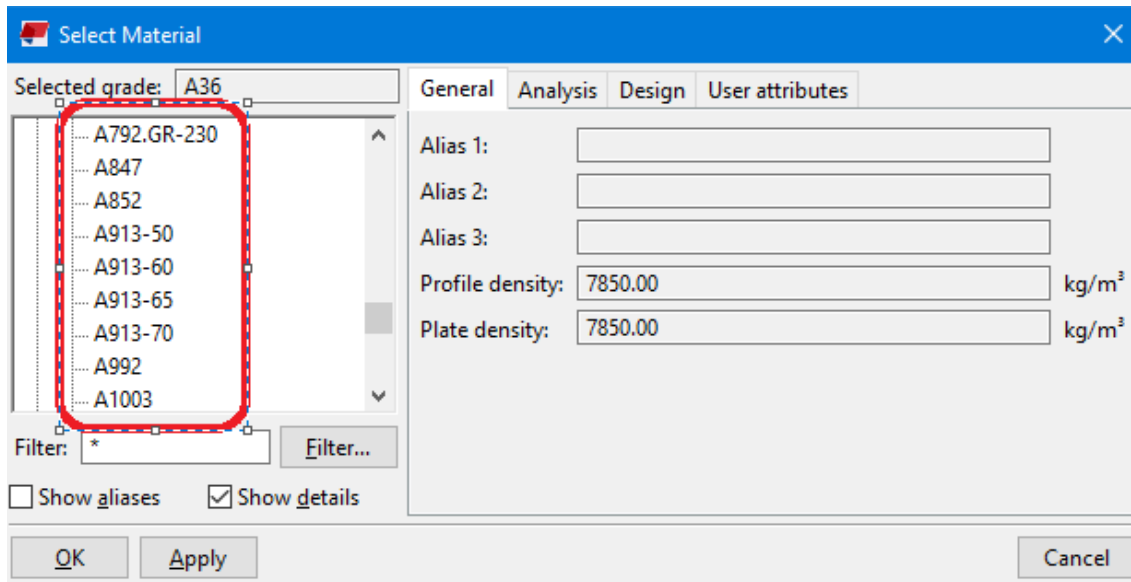

Note:

- Materials that are non-Hot Rolled Steel are not mapped through the link at this time.

Material Properties Mapping

Within a given material the properties of that material are mapped between Tekla Structures and RISA-3D as follows:

Tekla Structures Name	RISA-3D Name
Modulus of elasticity	E
N/A	G (left blank and RISA will auto-calc this value)
Poisson's ratio	Nu
Thermal dilatation coefficient	Therm
Profile Density	Density
Yield Strength	Yield
N/A	Ry (defaults to 1.5)
Ultimate Strength	Fu
N/A	Rt (defaults to 1.2)

LIS Files

The Tekla Open API does not provide access to the Yield Strength and Ultimate Strength fields in Tekla. To access those fields the RISA-Tekla Link creates a .lis file at transfer time to retrieve these values. Here is how you can manually create a LIS file.

1. Go to the Material catalog

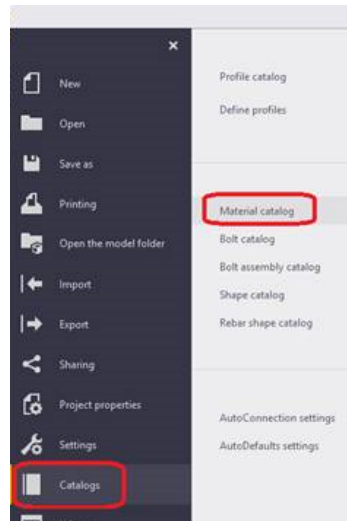

2. Choose your material and this will export the .lis file.

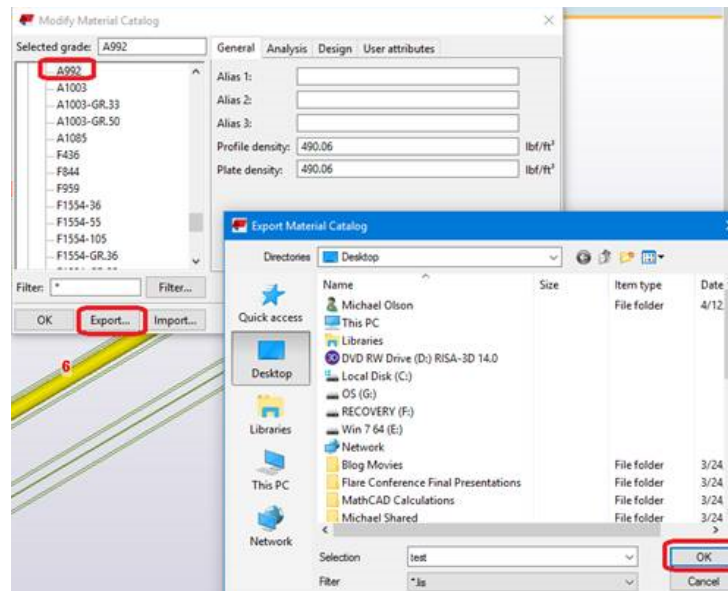

3. This .lis file has all of the properties for the material in it. The program generates this file and then reads the "AISC.YIELD_STRENGTH" as "Yield" and "AISC.ULTIMATE_STRENGTH" as "Fu".

```

Mike1.lis - Notepad
File Edit Format View Help

MATERIAL_NAME = "A992"; MATERIAL_TYPE = 1;
{
  ALIAS_NAME1      ***
  ALIAS_NAME2      ***
  ALIAS_NAME3      ***
  PROFILE_DENSITY  7.850002E+003,
  PLATE_DENSITY    7.850002E+003
  MODULUS_OF_ELASTICITY 1.999480E+011
  POISSONS_RATIO   3.000000E-001
  THERMAL_DILATATION 1.170000E-005
  ACTIVE_DESIGN_CODE 2
  USMETRIC.YIELD_STRENGTH 0.000000E+000
  USMETRIC.ULTIMATE_STRENGTH 0.000000E+000
  AISC.YIELD_STRENGTH 3.447379E+008
  WEIGHT_PER_UNIT_LENGTH 0.000000E+000
  AISC.ULTIMATE_STRENGTH 4.481592E+008
};

```

Boundary Conditions and End Releases

When viewing the Tekla Structures analysis model, you can double-click on a member to view the **Start releases** and **End releases** tabs. These tabs control BOTH boundary conditions and end releases in RISA-3D.

If the **Support condition** is *Supported* then RISA-3D will use a boundary condition. If the **Support Condition** is *Connected* then RISA-3D will use an end release.

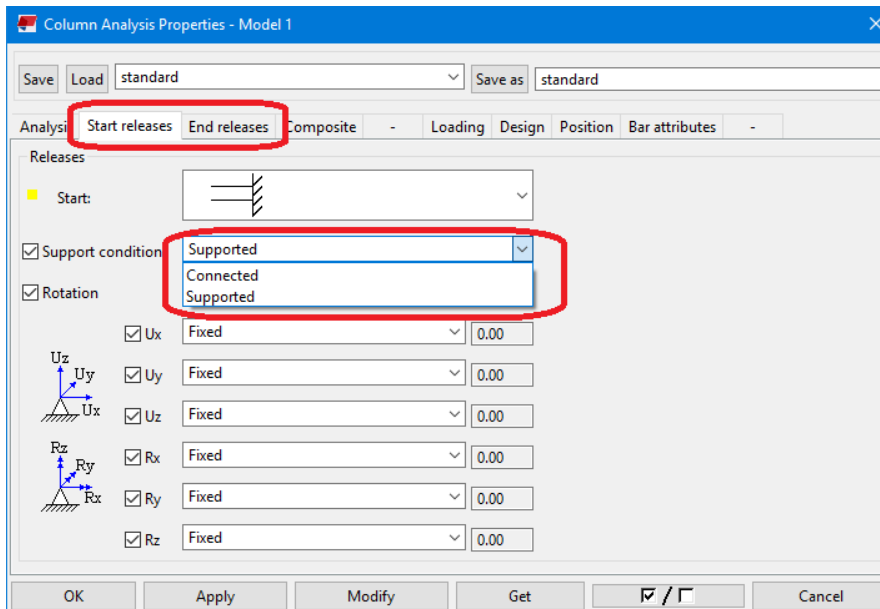

Boundary Conditions

If Supported is selected then the direction is mapped as follows:

Tekla Direction	RISA-3D Direction
Ux	X
Uy	Y
Uz	Z
Rx	MX
Ry	MY
Rz	MZ

The terminology is mapped as follows:

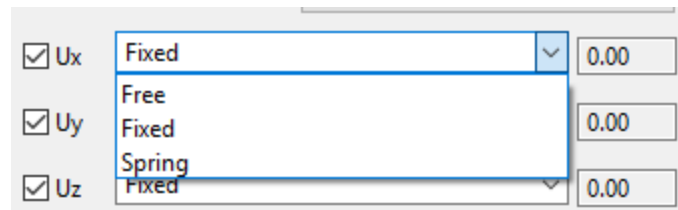

Tekla Condition	RISA-3D Condition
Free	Free
Fixed	Reaction
Spring & Value	Spring & Value

End Releases

For end releases things get a little more complicated. The first case below considers the **Support Condition** if it is **Supported**. All other items consider the **Support Condition** as **Connected**.

Tekla Condition	RISA-3D Condition
Support Condition = Supported	Fully Fixed
All 6 (Ux, Uy, Uz, Rx, Ry, Rz) Fixed	Fully Fixed
Ux, Uy, Uz, Rx Fixed, Ry, Rz Pinned	Bending Moment Released (Torsion Fixed)
Ux, Uy, Uz Fixed, Rx, Ry, Rz Pinned	Full Moment Release (Including Torsion)
Uy, Uz, Rx, Ry, Rz Fixed, Ux Pinned	
All Other Cases	Ux = Axial, Uy = y Shear, Uz = z Shear, Rx = Mx (Torsion), Ry = My, Rz = Mz
Spring	Free
Partial Release	Free

The end releases for the physical model can differ than the end releases for the analytical model in TEKLA. When exporting the RISA model to TEKLA, the end releases will be applied to the analytical model. Therefore, it is necessary to review the end releases of the analytical and physical model after each successive import or export of the model.

Reaction & Load Mapping

Tekla Structures and RISA-3D are capable of transferring loading information with the link for Point and Line loads. Here we will talk about how this works.

Reaction Considerations (Import Only)

When importing a RISA-3D model file (.r3d extension) into Tekla Structures, **if there is a solution file present (._s extension) with the model file**, the program will import the reactions from that file.

Here is the **End Reactions** spreadsheet in RISA-3D for a specific member:

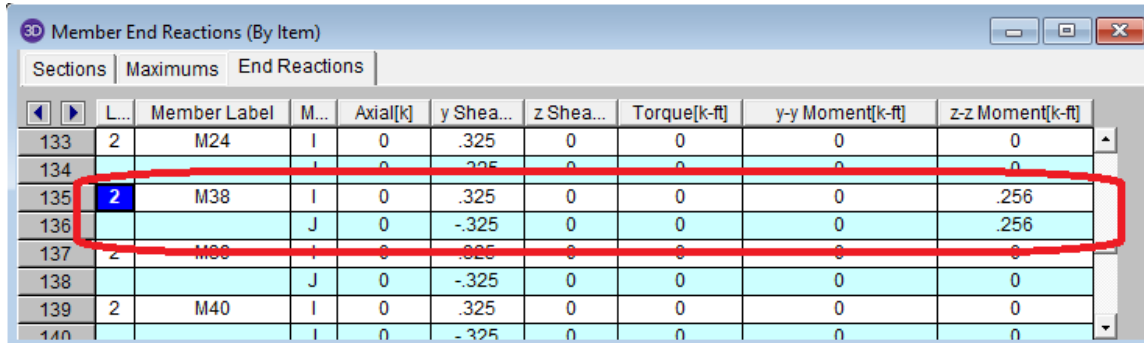

The screenshot shows a spreadsheet titled "Member End Reactions (By Item)". The "End Reactions" tab is selected. The spreadsheet has columns for L..., Member Label, M..., Axial[k], y Shea..., z Shea..., Torque[k-ft], y-y Moment[k-ft], and z-z Moment[k-ft]. Row 135 is highlighted with a red box, showing member M38 with a load of 2. The values for Axial, y Shear, z Shear, Torque, y-y Moment, and z-z Moment are 0, .325, 0, 0, 0, and .256 respectively.

L...	Member Label	M...	Axial[k]	y Shea...	z Shea...	Torque[k-ft]	y-y Moment[k-ft]	z-z Moment[k-ft]
133	2	M24	I	0	.325	0	0	0
134			I	0	.325	0	0	0
135	2	M38	I	0	.325	0	0	.256
136			J	0	-.325	0	0	.256
137	2	M38	I	0	.325	0	0	0
138			J	0	-.325	0	0	0
139	2	M40	I	0	.325	0	0	0
140			I	0	-.325	0	0	0

Here is what the **End Conditions** look like in Tekla Structures for this member after it's imported from RISA-3D:

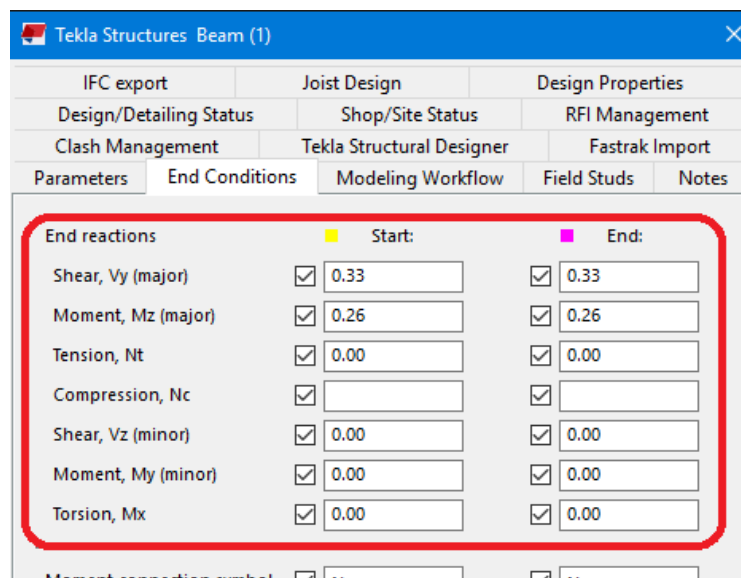

The screenshot shows the "End Conditions" dialog in Tekla Structures. The "End reactions" section is highlighted with a red box. It lists various reaction types with checkboxes and input fields for "Start" and "End" values. The values for Start and End are 0.33 for Shear, Vy (major), 0.26 for Moment, Mz (major), and 0.00 for Tension, Nt, Compression, Nc, Shear, Vz (minor), Moment, My (minor), and Torsion, Mx.

End reactions	Start:	End:
Shear, Vy (major)	<input checked="" type="checkbox"/> 0.33	<input checked="" type="checkbox"/> 0.33
Moment, Mz (major)	<input checked="" type="checkbox"/> 0.26	<input checked="" type="checkbox"/> 0.26
Tension, Nt	<input checked="" type="checkbox"/> 0.00	<input checked="" type="checkbox"/> 0.00
Compression, Nc	<input checked="" type="checkbox"/>	<input checked="" type="checkbox"/>
Shear, Vz (minor)	<input checked="" type="checkbox"/> 0.00	<input checked="" type="checkbox"/> 0.00
Moment, My (minor)	<input checked="" type="checkbox"/> 0.00	<input checked="" type="checkbox"/> 0.00
Torsion, Mx	<input checked="" type="checkbox"/> 0.00	<input checked="" type="checkbox"/> 0.00

Note:

- The End Reactions checkbox in the RISA-Tekla Link import dialog box must be checked for the reactions from RISA to transfer.
- If a Single Load Combination is imported it is a one-to-one transfer.
- If a Batch + Envelope solution is imported the envelope reactions will be brought into Tekla Structures interface and the remaining combinations are written to the Tekla Structures model file directory.
- If an Envelope Only solution is run, RISA's envelope member reactions are transferred into Tekla.

Self-Weight

No direct self-weight mapping is considered in the RISA-Tekla Link. However, if doing an **Export** from Tekla Structures to RISA-3D the link will automatically populate the self-weight flag in RISA-3D.

This is done by putting a "-1" in the Z Gravity column of the first Basic Load Case defined with a category of DL.

	BLC Description	Category	X Gravity	Y Gravity	Z Gravity	Joint	Point	Distrib
1	Group 1	SL			-1		2	
2	Group 2	DL						
3	Group 3	DL					3	
4	Group 4	DL					2	
5	Misc3	SL					1	
6	Misc1	ELZ				3		
7	Misc2	TL				1		
8		None						

Note:

- If there is no DL defined then this "-1" entry will not be input.

Load Categories

In Tekla Structures the available Load Types/Categories are based on which **Load category code** is selected.

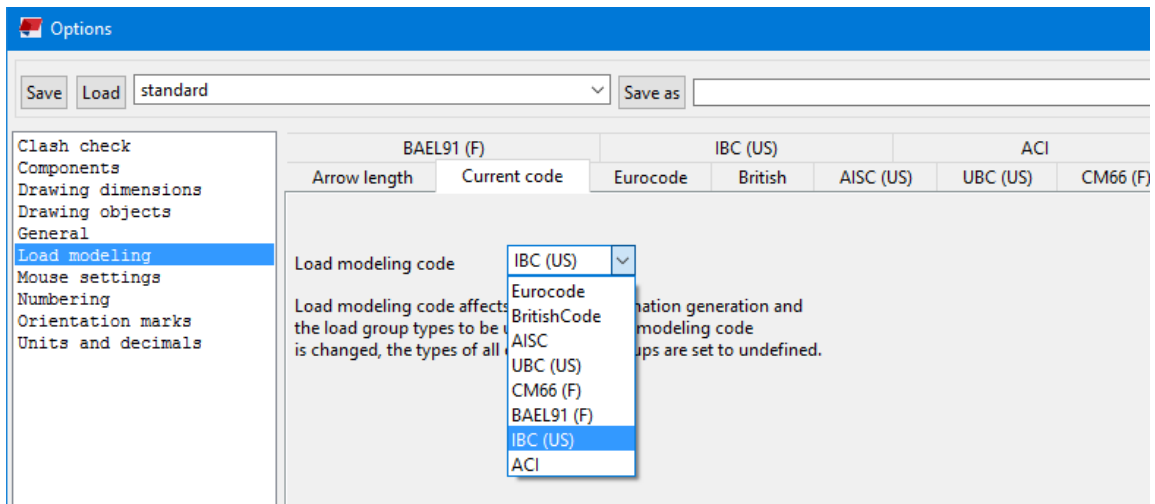

Different load categories are available depending on the code.

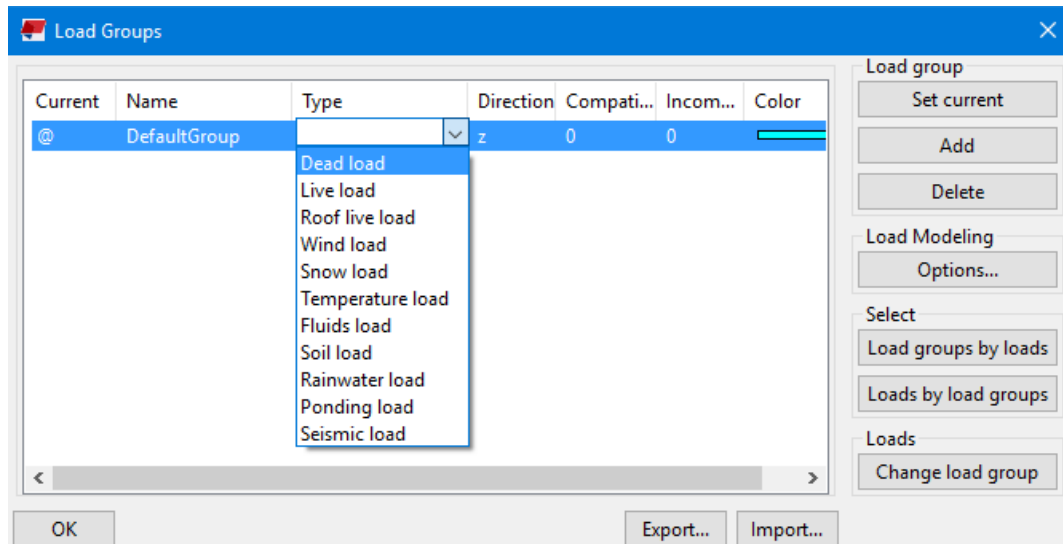

RISA-3D will support any of the **Load category codes** and **Load Types** based on the table below:

RISA-3D Load Cat	Tekla Structures Load modeling code						
	IBC (US)/UBC (US)	AISC	ACI	Eurocode	British Code	CM66 (F)	BAEL91 (F)
DL	Dead Load	Dead Load	Dead Load	Permanent Load	Dead load	PermanentLoad	PermanentLoad
LL	Live Load	Live Load	Live Load	Live load/ALL, Traffic load/ALL,	Imposed load	Exploitation load	Exploitation load
RLL	Roof live load	Roof live load	Roof live load				
WL	Wind Load	Wind Load	Wind Load	Wind Load	Wind load	Wind load	Wind load
SL	Snow Load	Snow Load	Snow Load	Snow Load		Snow load	Snow load
TL	Temperature load		Temperature load	Temperature Load	Temperature load	Temperature load	
FL	Fluid Load		Fluid Load				
HL	Soil Load		Soils Load				
RL	Rainwater load	Rainwater load	Rainwater load				
PL	Ponding load						
EL	Seismic Load		Seismic Load	Earthquake load		Seismic load horz/vert	Seismic load
OL1				Pre-Stress Load	Vertical crane load		Accidental load
OL2				Imperfection load due to dead loads	Horizontal crane load		
OL3				Imperfection load due to live loads			
OL4				Imperfection load due to snow loads			
OL5				Accidental load			
OL6				Ice Load			
OL7				Special permanent load			
OL8				Variable load 1			
OL9				Variable load 2			
OL10				Variable load 3			

The **BLC Description** in RISA-3D will match the **Name** in Tekla Structures and the Load Category will be mapped based on the table above.

	BLC Description	Category	X Gravity	Y Gravity
1	Dead load	DL		
2	Live load	LL		
3	Roof live load	RLL		
4	Wind load	WL		
5	Snow load	SL		
6	Temperature load	TL		
7	Fluid load	FL		
8	Soil load	HL		
9	Rainwater load	RL		
10	Ponding load	PL		
11	Seismic load	EL		
12		None		
13		None		

For Seismic and Wind loading we will break out the Categories between WL, WLX and WLZ, depending on the direction of the load. If the load is defined in the x-direction, then create a category WLX and the Description should be Wind load X. If defined in the z-direction, then create a category WLZ and the Description should be Wind load Z. Similar for Seismic. If the load is applied in any other direction then what is circled below then place the load in the WL category.

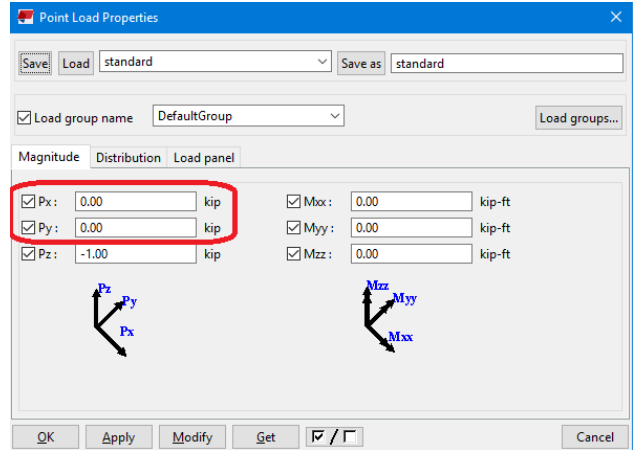
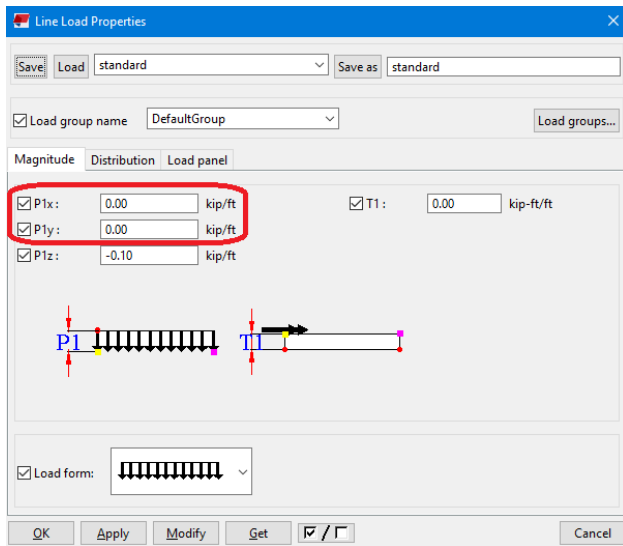

Load Combinations

Currently transfer of load combinations is not supported, either from Tekla Structures to RISA-3D or vice versa.

Point/Joint Loads

Tekla Structures uses the terminology of **Point Load**. RISA-3D has a terminology of **Joint** or **Point** and will transfer them based on whether the load lands on a Tekla Structures node or not. If a **Point Load** in **Tekla Structures** is defined on a **Node** then it will be transferred as a **Joint Load** in RISA-3D. If it is not then it will come into RISA-3D as a **Point Load**.

Point loads will transfer as long as the "Loads" checkbox is checked on the Import/Export dialog. The program considers the fields circled below in transferring loads.

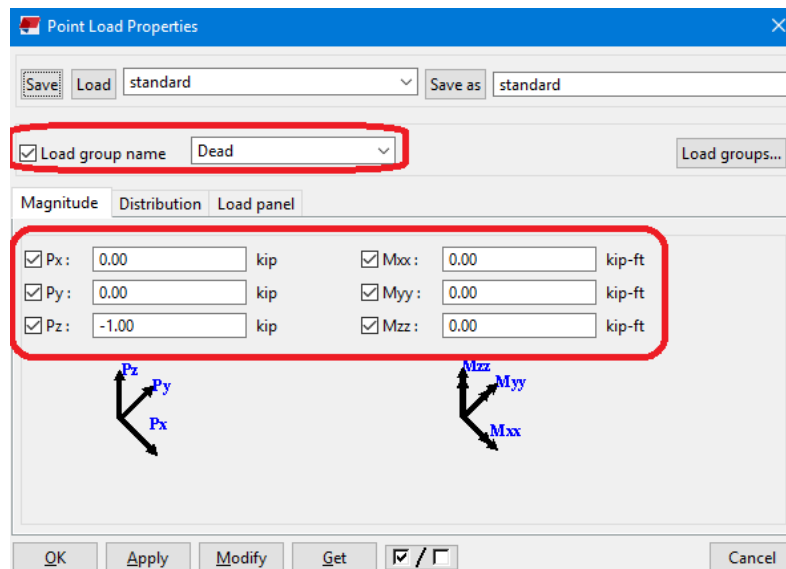

Tekla Direction	RISA-3D Direction
Px	X

Tekla Direction	RISA-3D Direction
Py	Y
Pz	Z
Mxx	MX
Myy	MY
Mzz	MZ

Note:

- No other field (other than what is above) is considered in the transfer.
- Point moments that are not applied to a joint in Tekla Structures will not be transferred to RISA-3D, as RISA-3D does not allow this. Instead a warning message will occur with the link. To fix this add a node in the Tekla Structures model at the location of the point moment.

Line Loads

Line loads will transfer as long as the "Loads" checkbox is checked on the Import/Export dialog. The program considers the fields circled below in transferring loads.

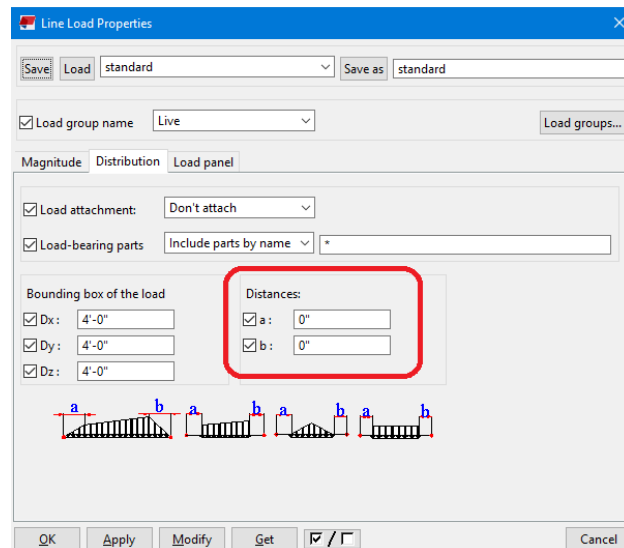
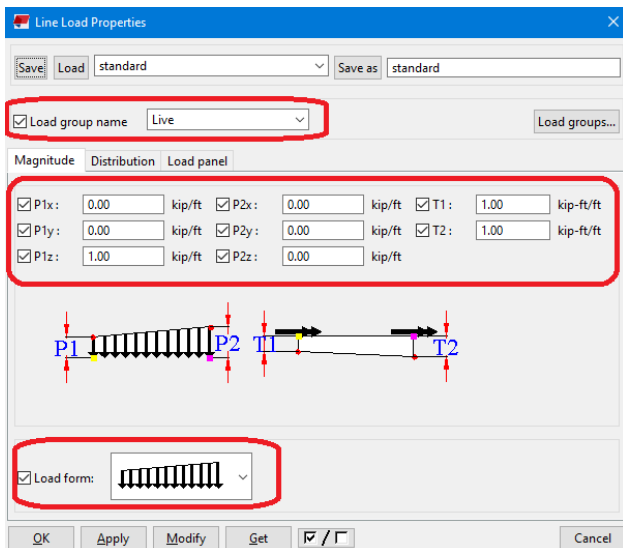

Tekla Direction	RISA-3D Direction
Px	X
Py	Y
Pz	Z
T	MX

Notes:

- In Tekla Structures it is possible to put different loads in different directions in a single **Line Load**. If that is done RISA-3D will treat each direction as a separate load.



•



- These **Load forms** are not currently supported
- No other field (other than what is above) is considered in the transfer.

In Tekla Structures it is possible to put different loads in different directions in a single **Line Load**. If that is done RISA-3D will treat each direction as a separate load.

In Tekla Structures it is possible to put different loads in different directions in a single **Point** or **Line Load**. If that is done RISA-3D will treat each direction as a separate load.

Miscellaneous Mapping Considerations

Design Information

Both Tekla Structures and RISA-3D contain member design information.

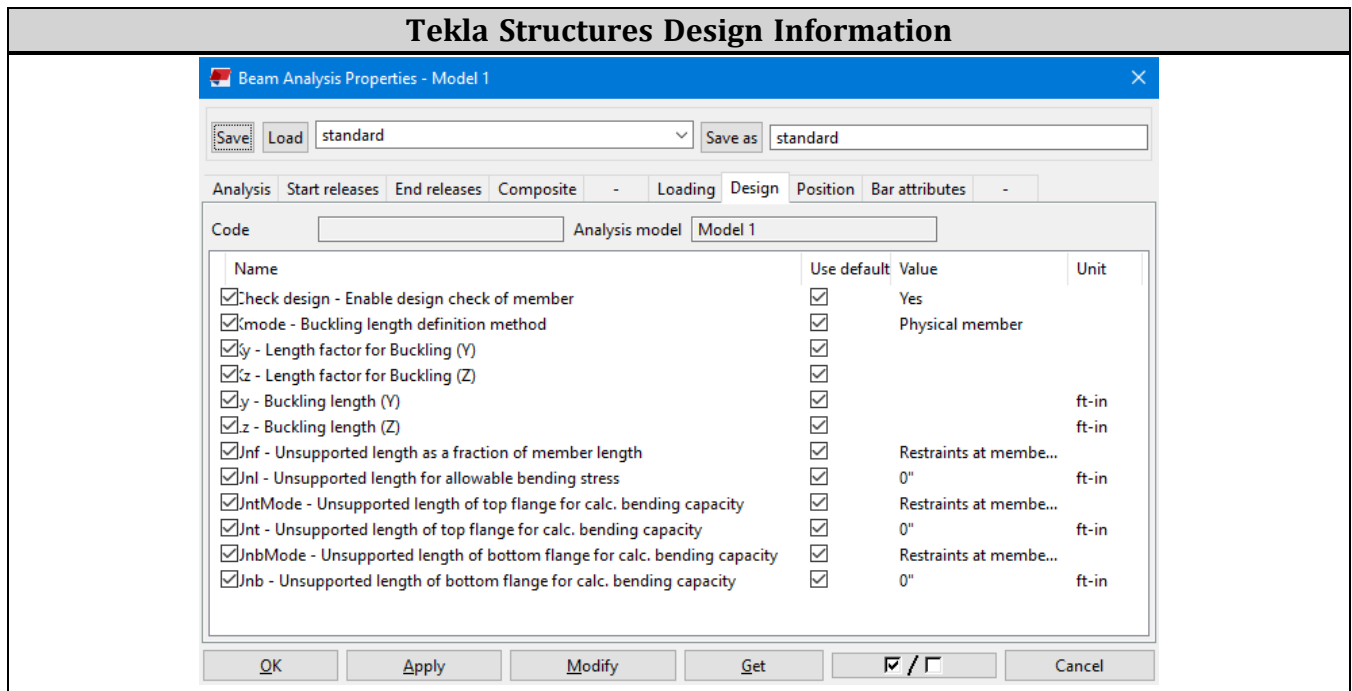

Label	Shape	Length...	Lbyy(ft)	Lbzz(ft)	Lcomp top(ft)	Lcomp bot(ft)	L-torque(ft)	Kyy	Kzz	Cb	Function
1 Tek_M42	LL4X4X8X6	20	2		2					1	Gravity
2 Tek_M43	LL4X4X8X6	7.5	8		8					1	Gravity
3 Tek_M44	LL4X4X8X6	12.5								1	Gravity
4 Tek_M45	LL4X4X8X6	12.5								1	Gravity
5 Tek_M46	LL4X4X8X6	12.5								1	Gravity
6 Tek_M47	W16X40	15	11	11						1	Gravity
7 Tek_M48	W16X40	15						2.1	2.1	1	Gravity
8 Tek_M49	W16X40	15								1	Gravity
9 Tek_M50	W16X40	15								1	Gravity

The following information is mapped. All other information will be left blank.

Tekla Information	RISA-3D Information
Ky - Length factor for Buckling (Y)	Kyy
Kz - Length factor for Buckling (Z)	Kzz
Ly - Buckling Length (Y)	Lbyy

Tekla Information	RISA-3D Information
Lz - Buckling Length (Z)	Lbzz
UntMode - Unsupported length of top flange for calc. bending capacity*	Lcomptop
Unt - Unsupported length of top flange for calc. bending capacity	Lcomptop
UnbMode - Unsupported length of bottom flange for calc. bending capacity*	Lcompbot
Unb - Unsupported length of bottom flange for calc. bending capacity	Lcompbot

* The **UntMode** and **UnbMode** will be set to **Restraint at member ends** if the member is unbraced over it's length. It will be set to **Use parameter Unt/Unb for the distance between restraints**.

Note:

- The **Segment** command for unbraced lengths is not supported with the import from RISA-3D to Tekla Structures. A warning will be given.
- The **Lbyy** command for unbraced lengths is supported with the import from RISA-3D to Tekla Structures.
- When importing **Kyy** and **Kzz** the Tekla OpenAPI may round up the values to the nearest 0.1.

Node/Joint Transfer

Tekla Structures and RISA-3D both have node/joints defined in the model. These will be transferred based on their 3D location in the model.

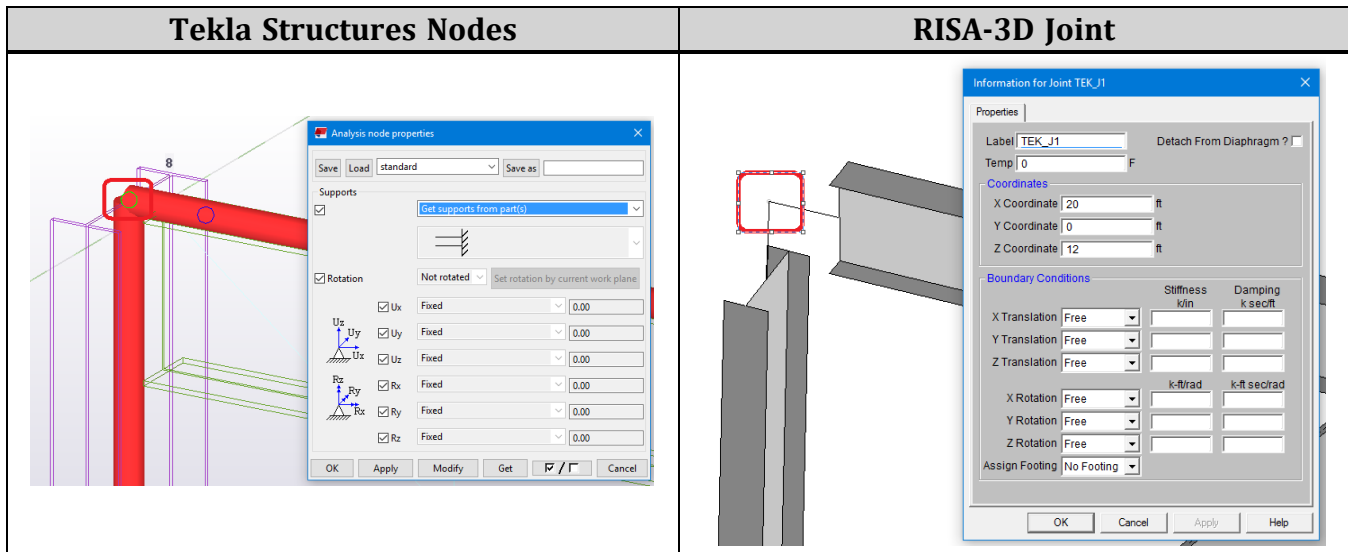

Note:

- The RISA-Tekla Link does not consider **User-defined node supports**

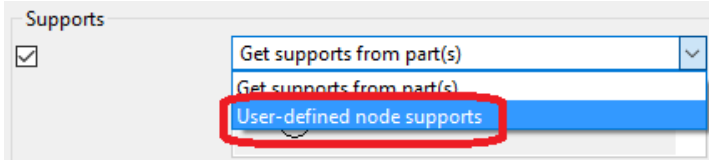

RISA Member Label

The RISA member label will transfer to the Tekla Structures model. To access this information, right click on a member and select **Inquire - Part** and the RISA member label information is listed at the bottom of the dialog:

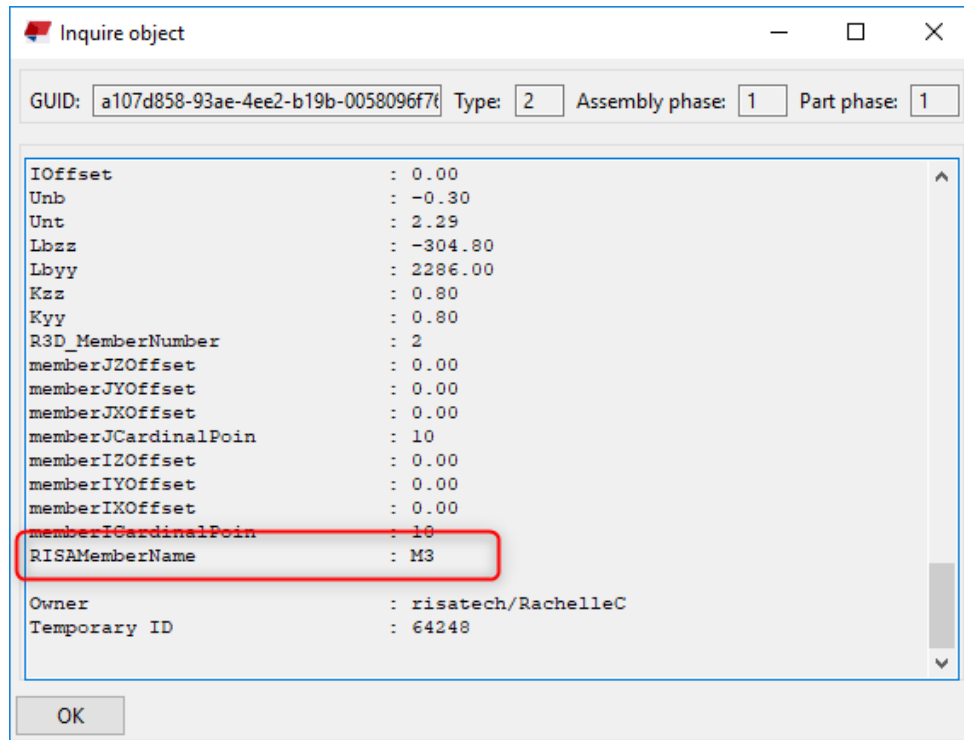

End Offsets

Both the Tekla Structures analysis model and RISA-3D allow you to use end offsets. Below is how mapping works for these inputs.

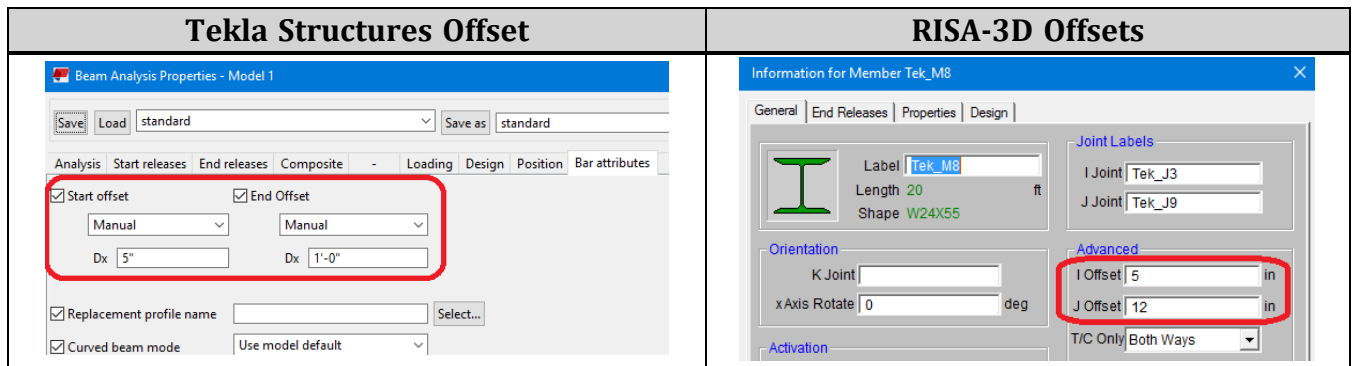

Note:

- The offsets will only transfer from Tekla Structures to RISA-3D if the offsets are set to **Manual**.
- The RISA-Tekla Link will properly convert member labels (M7 for example) into their equivalent d/2 value when importing a RISA-3D model into Tekla Structures.

Model Back-Up Behavior

Exporting from Tekla Structures to RISA-3D:

The exchange file is created when the Tekla model is exported to RISA-3D. RISA-3D opens that exchange file and creates a .r3d model file based on the information in the exchange file. The RISA-Tekla Link creates a ".rxc" file that is a copy of the RISA-3D file. The user can change the model in RISA-3D and save the modified changes in the ".r3d" model but the ".rxc" file does not change with this action. The ".rxc" file will contain the information in the RISA model that is identical to the Tekla model during the previous export. The user may delete the ".exc" file and rename the extension of the ".rxc" file to ".exc" and delete the RISA-3D model file to revert back to the state of the model during the last export from Tekla to RISA.

Importing a RISA-3D model into Tekla:

The Tekla Link uses the Tekla Structures model that is currently open in Tekla regardless of whether the Tekla model is saved or not. The user has the opportunity to decide when to save the Tekla model. The user can return at any time to the last saved model in Tekla because the link allows the user to export and import with RISA-3D without saving the Tekla model.

Warning and Error Log - RISA-3D

Below is a list of the warnings and errors in the link and further explanation for items which require it.

Export Warning Messages in the RISA-3D/Tekla Link

Code	Message	Explanation
W1001	The member GUID XX is not transferred because the link does not support polybeams.	To get your beam member to export you must change it to a Beam rather than a Polybeam.
W1002	The member GUID XX is not transferred because the link does not support curved beams.	To get your beam member to export you must change it to a Beam rather than a Curved Beam. Drawing the curved beam as straight-line beam segments could be one approach.
W1003	The member GUID XX is not transferred because the link only supports angle members as a twin profile.	RISA-3D only has a "double" database for angles. Back to back channels, for example, need to be drawn as two separate elements to transfer.
W1004	The member GUID XX is not transferred to RISA-3D because the RISA-Tekla Link doesn't support transferring member with such orientation of Double Angles in Twin profile	Twin profile types are not supported and is a current program limitation.
W1005	The member GUID XX has an unsupported profile type. The default profile type is used.	This member's cross-section is not mapped between Tekla Structures and RISA-3D. You'll need to use the Mapping File Editor to link these two shapes and then re-transfer your model.
W1010	The member GUID XX material XX is unsupported in this environment and will be transferred as the default XX shape and A992 material.	If you open a file in an environment that the file was not created in then this warning will occur when using the link.
W1011	The member GUID XX material XX is not a hot-rolled steel material in this environment. It will be transferred as the default W16X40 shape and A992 material.	The link currently only supports hot-rolled materials. Thus, any other material shape will be transferred as hot-rolled steel.
W1012	The member GUID XX shape's profile is not determined in this environment and will be transferred as a default XX shape.	The link couldn't understand the shape profile, thus it is brought in as the default shape.
W1020	The moment load XX not be transferred to RISA-3D.	Point moments that are not applied to a joint in Tekla Structures will not be transferred to RISA-3D, as RISA-3D does not allow this. Instead a warning message will occur with the link. To fix this add a node in the Tekla Structures model at the location of the point moment.
W2000	The Grid doesn't have an equal number of labels and coordinate values in the model. Only the matching labels and coordinates are transferred with the link.	If the number of Coordinate values doesn't match the number of Labels in the Grid then this warning is given.

Code	Message	Explanation
		<div style="border: 1px solid gray; padding: 5px;"> <p>Coordinates</p> <p><input checked="" type="checkbox"/> X <input type="text" value="0' 4'20'-0''"/></p> <p><input checked="" type="checkbox"/> Y <input type="text" value="0' 3'15'-0''"/></p> <p><input checked="" type="checkbox"/> Z <input type="text" value="0' 10'-0' 16'-0' 20'-0''"/></p> <p>Labels</p> <p><input checked="" type="checkbox"/> X <input type="text" value="1 2 3 4 5"/></p> <p><input checked="" type="checkbox"/> Y <input type="text" value="A B C D"/></p> <p><input checked="" type="checkbox"/> Z <input type="text" value="+0 +10 +16 +20"/></p> </div>
W2040	Non-Linear Line Load XX not supported currently with the link. This load is ignored.	<p>If you generate a line load of these two shapes it will be ignored currently with the link.</p> 
W2050	Load combinations are not currently transferred	The link currently does not support the transfer of load combinations.

Import Warning Messages in the RISA-3D/Tekla Link

Code	Message	Explanation
W5000	The coordinate system is converted so that the Z-axis is vertical.	This will occur if you have assigned a connection to RISACconnection that is not supported.
W5002	Member XX is not transferred to Tekla Structures because the link does not currently support cold-formed materials.	Cold-formed materials are not currently supported.
W5003	Member XX is not transferred to Tekla Structures because the link does not currently support wood materials.	Wood materials are not currently supported.
W5004	Member XX is not transferred to Tekla Structures because the link does not currently support general materials.	General materials are not currently supported.
W5005	Member XX is not transferred to Tekla Structures because the link does not currently support concrete materials.	Concrete materials are not currently supported.
W5006	Member XX is not transferred to Tekla Structures because the link does not currently support aluminum materials.	Aluminum materials are not currently supported.
W5011	Member XX has a shape not recognized in this environment. The shape may not be mapped or may not be saved in the ais-cdb32.fil/canada32.fil. Default shape XX used.	If a shape is not mapped properly from RISA-3D to Tekla Structures then this shape name may not be mapped. Use the Mapping File Editor to map this shape and re-transfer the model.
W5012	Member XX is defined as a Column in RISA-3D but is non-vertical so is updated to a Beam in Tekla Structures	In Tekla Structures if a member is not completely vertical it must be a beam. Thus, the link updates these elements accordingly.
W5013	Member XX is defined as a Beam in RISA-3D but is vertical so is updated to a Column in Tekla Structures	In Tekla Structures if a member is completely vertical it must be a column. Thus, the link updates these elements accordingly.
W5020	Plates are not currently supported with the link and are not transferred to Tekla Structures.	The link doesn't support plates.
W5021	Wall panels are not currently supported with the link and are not transferred to	The link doesn't support wall panels.

Code	Message	Explanation
	Tekla Structures.	
W5022	Solids are not currently supported with the link and are not transferred to Tekla Structures.	The link doesn't support solids.
W5030	Load combinations are not currently transferred	The link currently does not support the transfer of load combinations.
W5040	Unsupported material for member <MXX> Tekla Structures is using the default material "A36"	When importing from RISA-3D to Tekla Structures you MUST name your RISA-3D material label to the exact name in Tekla Structures. If the link doesn't find an exact match it will use the default A36 material.
W5101	Member XX uses Segment for unbraced length and this will be ignored in Tekla Structures	Segment is an unbraced length code in RISA-3D that is unrecognized and thus unsupported in Tekla Structures.
W5201	Member MXX is a Twin profile and it will be transferred as corresponding Single profile to Tekla Structures	The link is unable to support twin profiles currently with the link, so all double angles are brought in as single angles.
W5300	Member reactions not supported for an Envelope Only solution. Run a single load combination or a Batch solution to get results.	An Envelope Only solution is not commonly run in RISA-3D and thus is unsupported in the link.

Mapping Behavior

How Mapping Works

Tekla Structures and RISA-3D/RISACONNECTION have different nomenclatures for how elements are named. To map these names between the two programs a mapping file is generated by the RISA-Tekla Link for each Tekla Structures environment:

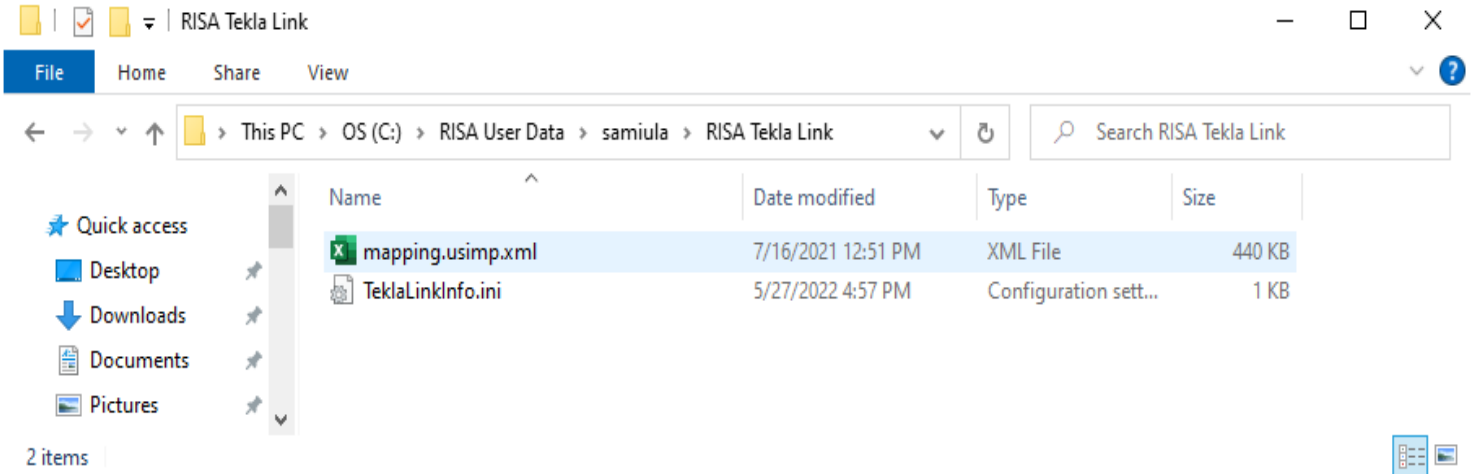

This mapping file contains materials, section names, etc., and maps Tekla Structures nomenclature to RISA-3D/RISACONNECTION and vice-versa. The mapping files are based on the default information in the Tekla Structures environments and the RISA-3D/RISACONNECTION shape databases. If new sections are added to these databases then they will ALSO need to be added to the mapping file for the RISA-Tekla Link to map these properties between programs.

Mapping File Editor

There is no problem opening the .xml mapping files in a spreadsheet program and making edits. However, the format of this file is somewhat difficult to understand. In lieu of this option there is a **Mapping File Editor** button, accessible a few different ways.

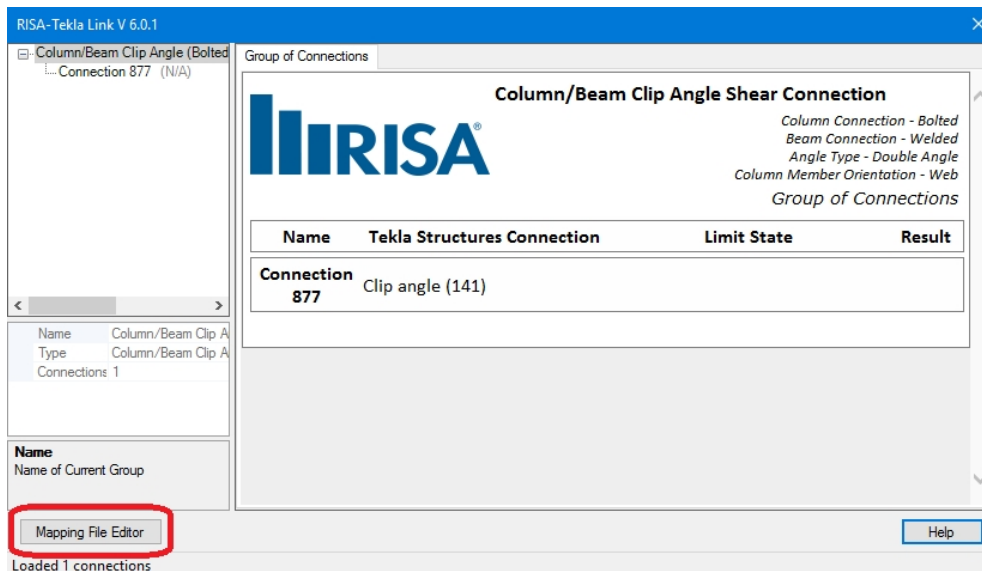

RISAConnection-Tekla Link Dialog

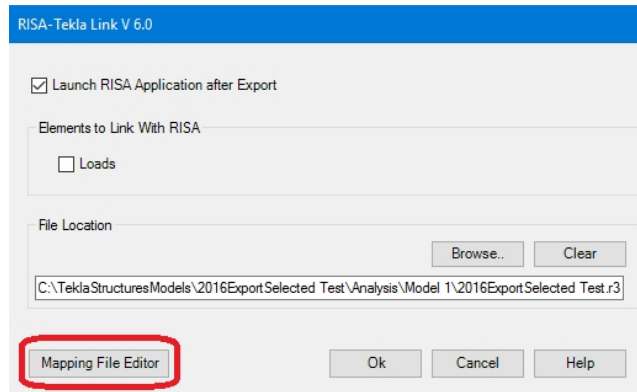

RISA-3D Tekla Link Export/Import Dialogs

When this button is pressed the Mapping File Editor will open. When it opens the program will read the shape, material and bolt information from the environment you are currently working in. It will also read from the associated RISA shape database. Finally, it will read and populate the dialog with information from the given mapping file.

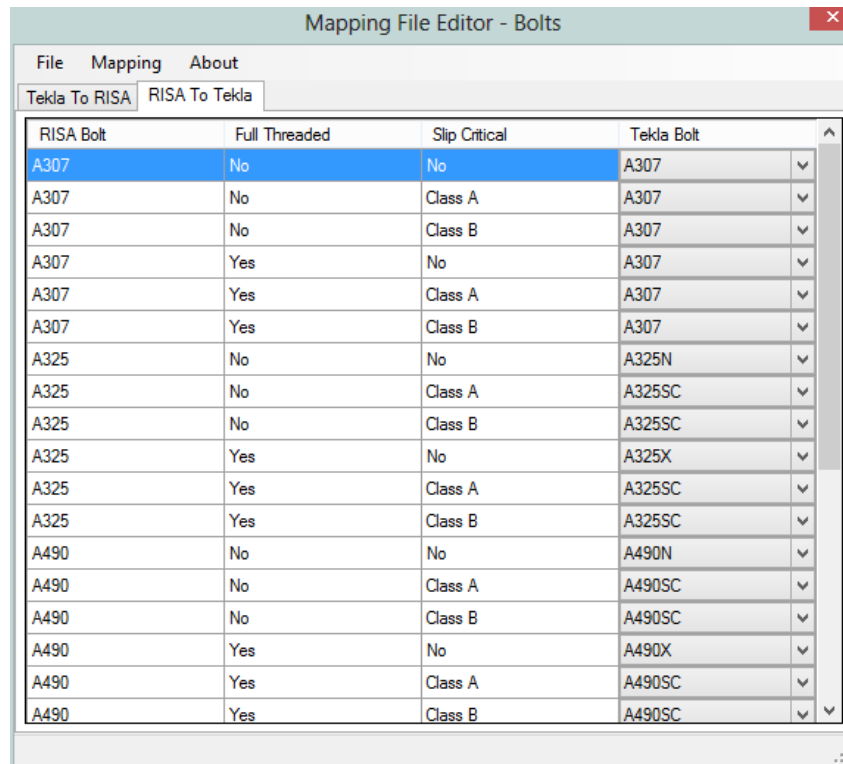

Note that in the **Mapping** drop-down list is where the option for profiles (shape), materials or bolts is located.

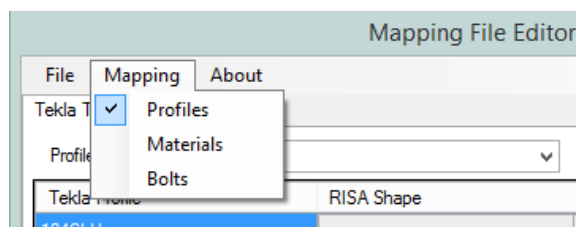

Each item (profiles, materials, bolts) has a separate view with both "Tekla to RISA" and "RISA to Tekla" tabs. When a change is made to mapping behavior this change will automatically occur on both tabs.

Note:

- Only elements that can be edited BOTH in Tekla Structures and RISACONNECTION will have information on both "Tekla to RISA" and "RISA to Tekla" tabs. W Shape profiles, for example, can only be edited in Tekla Structures. Thus, when viewing the "RISA to Tekla" tab there is no option to view W Shape profiles.

The About dialog will tell you which environment is being used, the mapping file URL and where the editor is looking for the RISA shapes database.

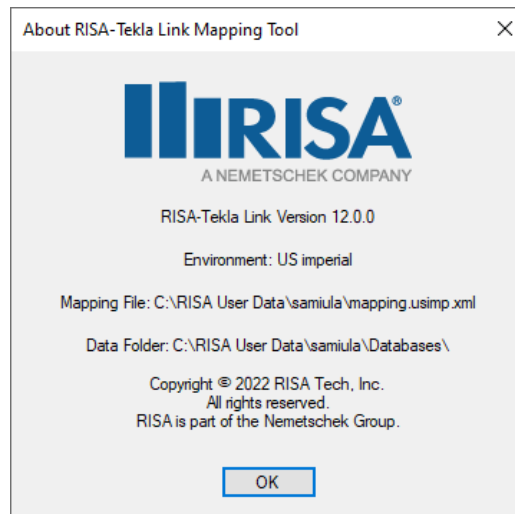

Note:

- The RISA-Tekla Link currently supports mapping for the **US Imperial** and **US Metric** for BOTH the RISA-3D and RISACONNECTION links. Additionally, the **UK, German, Sweden, Norway, China, India, and Australasia** environments are supported for RISACONNECTION ONLY.. See the [Before You Begin](#) topic for more information on different environment behavior.
- After a change is made to a mapping file you must go to **File - Save**. Once you save the file then Tekla Structures will prompt you to read in the mapping file again to account for this change.

Shape/Section Mapping

Member shapes are mapped between Tekla Structures and RISA by way of a mapping file. There is a default mapping file added at install time that has standard shapes mapped. To edit the mapping file you can open it directly. An easier way to edit, however, is via the [Mapping File Editor](#).

Note:

- The RISA-Tekla Link does not support parametric profiles. It only supports static profiles. If a connection contains a parametric profile, warning W3200-W3203 will be given and a default section/shape will be used.

Material Mapping

Materials are automatically mapped between Tekla Structures and RISACONNECTION for wide flanges, tubes, pipes, angles and plates. Tekla Structures has many materials not supported in RISACONNECTION. If RISACONNECTION does not support that material a warning will be given and a default material will be used.

Note:

- You can use the [Mapping File Editor](#) to map your material to something similar that is supported in RISAConnection.

Element GUID's

RISAConnection Link

The link uses two connection identifiers when referring to a specific connection with the link. The connection **GUID** is what the link maps to. This is a unique value for each connection. This value is a very long string, however, so the link uses the **CONNECTION_RUNNING_NUMBER** as the displayed name of the connection.

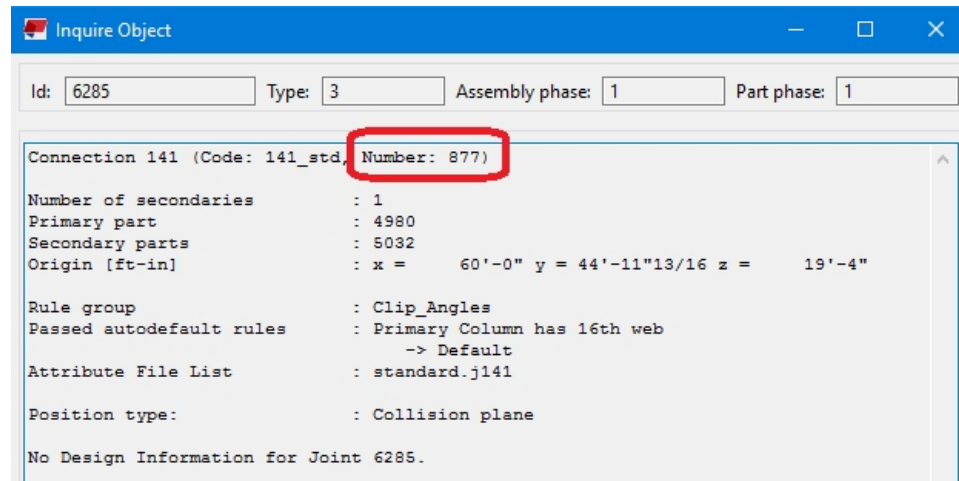

However, you can update this using the  button in Tekla Structures. See the [Application Interface](#) topic for more information on this.

RISA-3D Link

The link uses the object **GUID** when referencing an element.

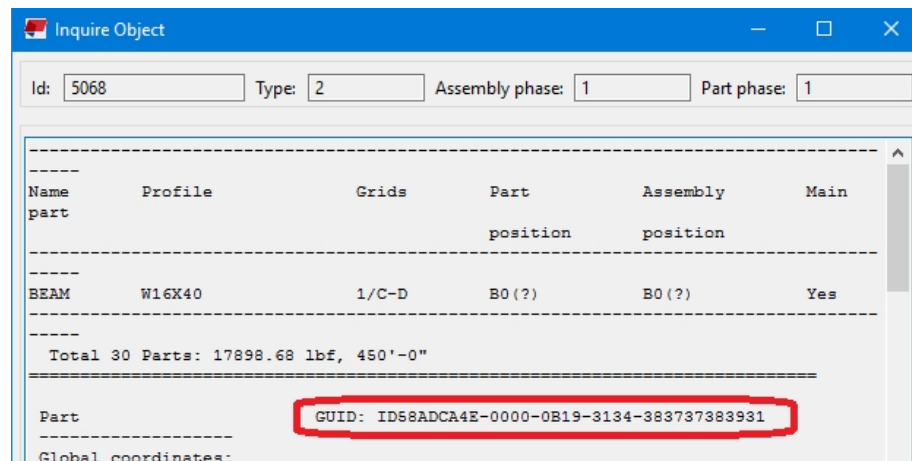

RISAConnection Specific Mapping Considerations

When transferring Tekla Structures connections to RISAConnection properties are mapped over from Tekla Structures to RISAConnection and vice-versa. Tekla Structures and RISAConnection are very different and were built for different applications. However, many properties can be mapped directly between the two programs.

Properties are characterized as one of three different classifications: read-only properties, editable properties and ignored properties. Here we will explore each classification.

Read-Only Properties

Read-only properties are properties brought in from Tekla Structures that can not be updated in RISACconnection. These are properties inherent to the structure itself. These include section properties, material properties and loading. These are items that in most cases the connection designer does not have control of. Thus, these properties must be edited in the Tekla Structures model and is read-only in RISACconnection. There are also some other properties that for mapping purposes are brought over as read-only as well.

Bolt Hole Configuration

In RISACconnection you can have multiple configurations that Tekla Structures does not support. Because of this it is required to set the bolt hole types in Tekla Structures only.

For more information see the [Bolt Hole Mapping](#) section.

Editable Properties

Editable properties are properties brought in from Tekla Structures that can be updated in RISACconnection. These are properties specific to connection design that the connection designer would have control over. This includes welds, bolt criteria, plate and clip angle criteria, offsets, etc. These properties, if updated in RISACconnection, will be updated in the Tekla Structures model when the results are exported back from RISACconnection.

Ignored Properties

Ignored properties are properties completely ignored by the RISA-Tekla Link. These are generally elements in Tekla Structures that are not supported in RISACconnection. Some examples of properties ignored by the link:

- Haunch plate information
- Fill information
- Folded plates and fitting plates
- Seat angles and seat plates

Mapping Priority

Tekla Structures has the ability to define/edit properties in a variety of ways. The RISA-Tekla Link maps properties between Tekla Structures and RISACconnection in the following priority order:

1. Using the properties found directly in the connection component.

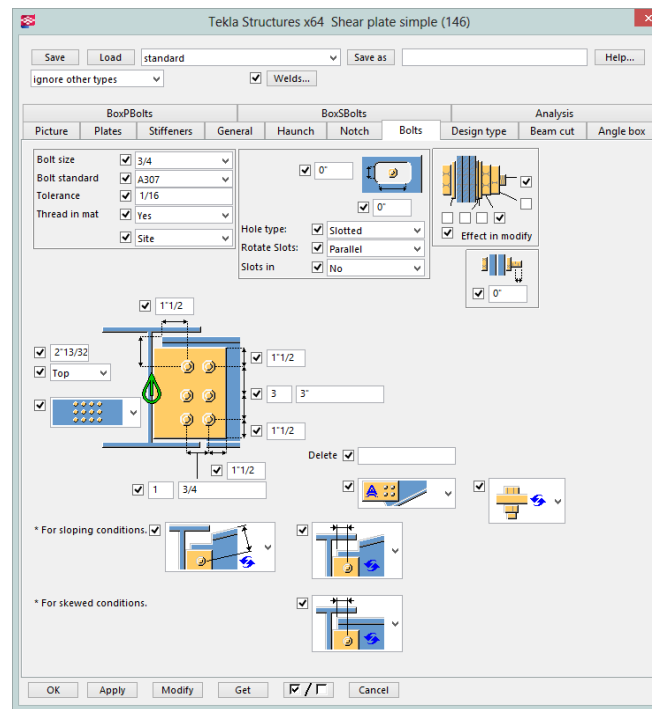

2. If the component doesn't have all of the information the RISA-Tekla Link will use the connection's individual object information.

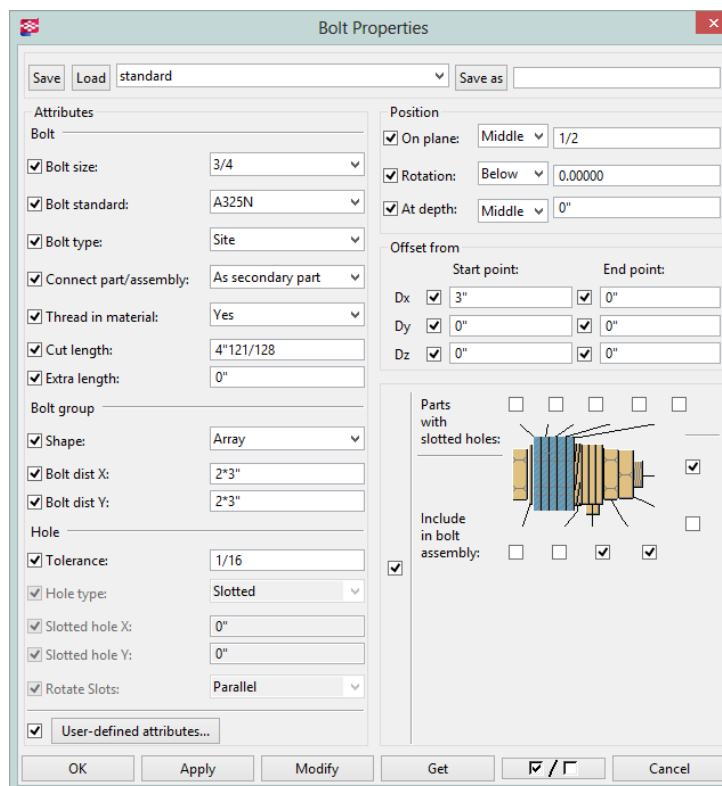

3. If both the component and the individual objects do not fully define the connection the RISA-Tekla Link will look to the **joints.def** file for information. See the Tekla Structures help for more information about the usage of this file.

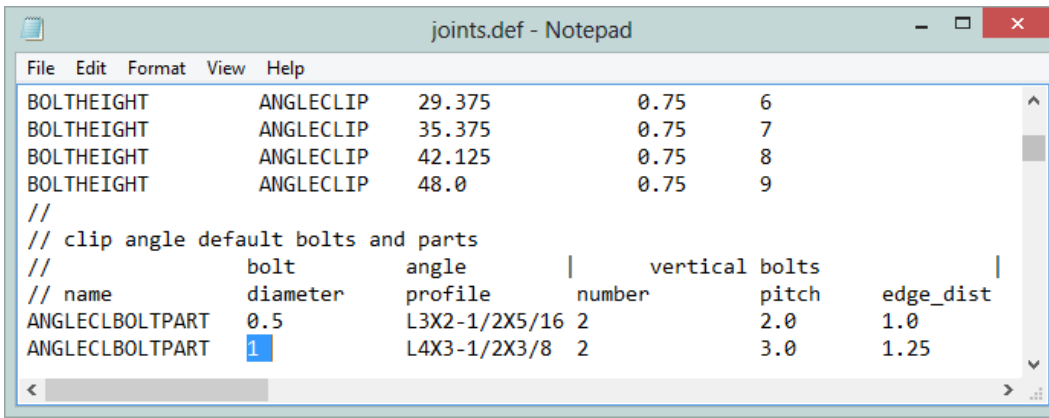

Tekla Structures uses the **joints.def** in specific folder sequences. The order that it looks in is:

- The model directory (*C:\TeklaStructuresModels\Tekla Model 1* for example).
- The XS_Project directory (Tools>Options>Advanced Options>File Locations) which is blank by default.
- The XS_Firm directory (Tools>Options>Advanced Options>File Locations) which is blank by default.
- The XS_System (this defaults to *C:\ProgramData\Tekla Structures\19.0\Environments\usimp\system* or *C:\ProgramData\Tekla Structures\19.0\Environments\Common\system* depending on whether you are using imperial or metric units)

Below is a table showing the possible values that could be used directly from the **joints.def** file.

Component 141	Component 144	Component 146	Component 134	Component 182
Beam bolt vert edge dist	Bolt vert edge dist	Plate thickness	Bolt vert edge dist	Plate thickness
Beam bolt horz edge dist	Bolt horz edge dist	Bolt vert edge dist	Bolt horz edge dist	Bolt vert edge dist
Column/girder vert edge dist	Rows of bolts	Bolt horz edge dist	Rows of bolts	Bolt horz edge dist
Column/girder horz edge dist	Row spacing	Rows of bolts	Row spacing	Rows of bolts
Rows of bolts	Columns of bolts	Row spacing	Columns of bolts	Row spacing
Row spacing	Column spacing	Columns of bolts	Column spacing	Columns of bolts
Columns of bolts	Cope width	Column spacing		Column spacing
Column spacing	Cope length	Cope width		
Cope width		Cope length		
Cope length				

Components 58, 59 and 60	Components, 11, 20, and 62	Component 184
Col/Gusset, Beam/Gusset, and Brace/Gusset bolt vert edge dist	Brace/Gusset bolt vert edge dist	Plate thickness
Col/Gusset, Beam/Gusset, and Brace/Gusset horz edge dist	Brace/Gusset horz edge dist	Bolt vert edge dist
Col/Gusset, Beam/Gusset, and Brace/Gusset Rows of bolts	Brace/Gusset Rows of bolts	Bolt horz edge dist
Col/Gusset, Beam/Gusset, and Brace/Gusset Row spacing	Brace/Gusset Row spacing	Rows of bolts
Col/Gusset, Beam/Gusset, and Brace/Gusset Columns of bolts	Brace/Gusset Columns of bolts	Row spacing

Components 58, 59 and 60	Components, 11, 20, and 62	Component 184
Col/Gusset, Beam/Gusset, and Brace/Gusset Column spacing	Brace/Gusset Column spacing	Columns of bolts
Gusset Dimensions	Gusset Dimensions	Column spacing
Diagonal Brace Dimensions	Diagonal Brace Dimensions	Cope width
		Cope length

4. If we can not find a property in any of the above 3 locations then RISACONNECTION will use it's own default value.

Other Mapping Considerations

Bolt Mapping

Slip-critical nomenclature is not identical between both programs. Here is how the mapping is defined in both directions for the US Imperial environment. The best way to see this information for other environments is from the [Mapping File Editor](#).

Tekla to RISA Translation			RISA to Tekla Translation		
Tekla Bolts	RISA Bolts		RISA Bolts		Tekla Bolts
Bolt Standard	Bolt Material	Slip Critical	Bolt Material	Slip Critical	Bolt Standard
A307	A307-N	No	A307-N	No	A307
A325M	A325M	No	A307-N	Class A	A307
A325MT	A325M	No	A307-N	Class B	A307
A325N	A325-N	No	A307-X	No	A307
A325N-DTI	A325-N	No	A307-X	Class A	A307
A325_TC	A325-N	No	A307-X	Class B	A307
A325_TC-DTI	A325-N	No	A325-N	No	A325N
A325N_TC-DTI	A325-N	No	A325-N	Class A	A325SC
A325SC	A325-N	Class A	A325-N	Class B	A325SC
A325SC_TC	A325-N	Class A	A325-X	No	A325X
A325T	A325-N	No	A325-X	Class A	A325SC
A325X	A325-X	No	A325-X	Class B	A325SC
A325X-DTI	A325-X	No	A490-N	No	A490N
A325X_TC	A325-X	No	A490-N	Class A	A490SC
A325X_TC-DTI	A325-X	No	A490-N	Class B	A490SC
A490M	A490M	No	A490-X	No	A490X
A490N	A490-N	No	A490-X	Class A	A490SC
A490N-DTI	A490-N	No	A490-X	Class B	A490SC
A490N_TC	A490-N	No	A325M	No	A325M
A490N_TC-DTI	A490-N	No	A325M	Class A	A325M
A490SC	A490-N	Class A	A325M	Class B	A325M
A490_SC_TC	A490-N	Class A	A325M	No	A325M
A490X	A490-X	No	A325M	Class A	A325M
A490X-DTI	A490-X	No	A325M	Class B	A325M

Tekla to RISA Translation			RISA to Tekla Translation		
Tekla Bolts	RISA Bolts		RISA Bolts		Tekla Bolts
Bolt Standard	Bolt Material	Slip Critical	Bolt Material	Slip Critical	Bolt Standard
A490X_TC	A490-X	No	A490M	No	A490M
A490X_TC-DTI	A490-X	No	A490M	Class A	A490M
			A490M	Class B	A490M
			A490M	No	A490M
			A490M	Class A	A490M
			A490M	Class B	A490M

Note:

- For slip-critical call-outs in Tekla Structures they do not give the faying surface. In this instance RISAConnection assumes conservatively a Class A faying surface.
- In any cases where the **Bolt Standard** does not state N or X the program will use the **Thread in Mat** input to determine this. If the **Thread in Mat** input is defined as "Default" or "Yes" then the "N" designation will be mapped. If defined as "No" then the "X" designation will be mapped.

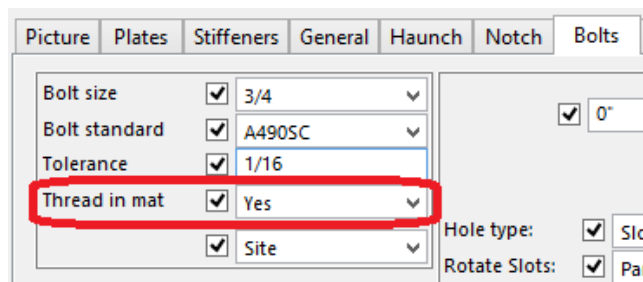

- The above information is the default mapping behavior. This mapping can be changed by using the [Mapping File Editor](#).

Weld Mapping

In the Tekla Structures components there is a button for welds:

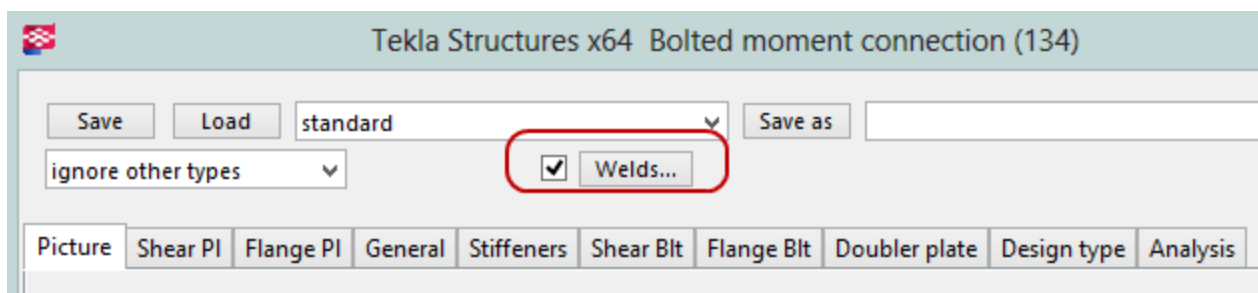

This is the place where the **Weld Size** and **Weld Type** is stored.

A couple of notes on this dialog:

- By default a large amount of welds are defined. Most likely all of these welds will not be used and a warning message will be created in the RISA-Tekla Link.
- For doubler plates in connection 134 it is weld 2 which controls the weld parameters for the weld from the doubler plate to the column. In Tekla Structures there is a single input for the doubler plate weld all the way

around. In RISACONNECTION there is a left/right input and a top/bottom input where these welds can be not. Because of this, any edits to the weld type or weld size must be done in Tekla Structures.

In Tekla Structures the **Electrode Classification** is almost never stored in the component. You must click on the individual weld object to view this information. The table shows how this information is mapped.

Tekla Electrode Classification	RISA Electrode Type
35	Unsupported (use E70)
42	Unsupported (use E70)
50	Unsupported (use E70)
E60XX	E60
E70XX	E70
E80XX	E80
E90XX	E90
E70XX*	E100
E70XX*	E110

Note:

- It is possible in RISACONNECTION to use E100 or E110 electrode types. However, Tekla Structures does not support these and the link will default to E70XX.
- Because the Electrode Classification is not stored in the component (only in the individual weld object), any modifications to the component will overwrite this information from the individual weld object with blank information. This will cause RISACONNECTION to bring in the default again the next time the model is linked.

Bolt Hole Mapping

In RISACONNECTION you can have multiple configurations that Tekla Structures does not support. Because of this it is required to set the bolt hole types in Tekla Structures only.

In Tekla it is possible to map the type of bolt holes to RISACONNECTION.

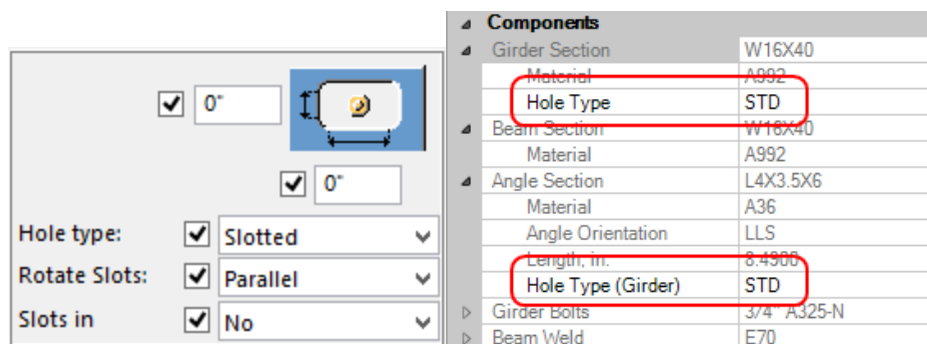

This is the nomenclature that is used:

Tekla Hole Type	Tekla Rotate Slots	RISA
Default	Odd	SSLH
Default	Even	SSLV
Default	Parallel	SSLH
Default	Default	STD
Slotted	Odd	LSLH
Slotted	Even	LSLV
Slotted	Parallel	LSLH

Tekla Hole Type	Tekla Rotate Slots	RISA
Slotted	Default	LSLH
Oversized	Any Value	OVS

If the hole dimensions are defined explicitly an warning will be generated and RISAConnection will default to a STD hole. RISAConnection bases the standard hole size (STD) and slotted hole sizes on values taken directly from the AISC steel manual. Again, if you input dimensions directly they will not be used.

Note:

- In RISAConnection it is possible to freely control the orientation of bolt holes for both the member and the connector. Tekla Structures is more restrictive. For this reason the bolt hole configurations can only be manipulated in Tekla Structures and RISAConnection will then read this information. You can not edit this information in RISAConnection.

Technical Support

Technical support is an important part of the RISA package. There is no charge for technical support for all licensed owners of the **current** versions of our software.

Hours: 6AM to 5PM Pacific Standard Time, Monday through Friday (excluding holidays)

Before contacting technical support, you should typically do the following:

1. **Please search the Help File or General Reference Manual.** Most questions asked about RISA products are answered in the Help File or General Reference Manual. Use the table of contents or index to find specific topics and appropriate sections.
2. If you have access to the Internet, you can visit our website at risa.com and check out our **Downloads** and **Support** section for release notes, updates, downloads, and frequently asked questions. We list known issues and product updates that you can download. So, if you think the program is in error you should see if the problem is listed and make sure you have the latest release.
3. Make sure you understand the problem, and make sure your question is related to the program or structural modeling. Technical Support does not include engineering consulting.
4. Take a few minutes to experiment with the problem to try to understand and solve it.

For all modeling support questions, please be prepared to send us your model input file via email. We often will need to have your model in hand to debug a problem or answer your questions.

Email: support@risa.com. This method is the **best** way to send us a model you would like help with. Make sure you tell us your name, company name, Key ID, phone number, and give a sufficient problem description.

Phone Support: (949) 951-5815. You can also call. But keep in mind that this works best only if your question is not model specific and therefore doesn't require us to look at your file.

Index

A

Application Interface 8, 16, 75, 79
Automatic Roundtrip Solution 27

B

Before You Begin 1
Bolt Hole Configuration 118
Bolt Hole Mapping 123
Bolt Mapping 121
Boundary Conditions & End Releases 100

C

Completing the Tekla Model 23
Component Specific Considerations 38
Configuring Connections 25
Connection Grouping 29
Connection Results Viewing in Tekla 26
Copyright 2

E

Environment Support 4
Error Messages 68
Export Warning Messages 111

F

Folder Structure 78, 81
Folder Structure - RISACONNECTION 14, 21

G

Graphical Results View - RISACONNECTION 13, 20
Grouping Behavior 30

I

Import Warning Messages 112
Installation 8

L

License Agreement 8
Loading 32

M

Mapping 114
Mapping File Editor 114
Material Mapping 116
Member Orientation 89
Miscellaneous Mapping Considerations 107

O

Overview 1

P

Program Capabilities 1

R

Registry and File Location Considerations 14, 21
RISA-3D Behavior 88
RISACONNECTION Behavior 29
RISACONNECTION Tekla Link Browser 11, 18
Roundtrip - RISA-3D 88
Round-tripping 37

S

Sending the Model to RISACONNECTION 23
Shape Mapping 116

Shape Type Mapping 89
Solving Connections 34
Solving in RISAConnection 25
Supported Roles 6
System Requirements 7

T

Technical Support 8, 125
Tekla Structures Interface - RISA-3D 76, 79
Tekla Structures RISAConnection Interface 8,
16

V

Viewing Results (in RISAConnection) 34
Viewing Results (in Tekla) 36

W

Warning Messages 54
Weld Mapping 122